

Temposonics®

Magnetostrictive Linear Position Sensors

Temposonics® R-Series

Brief Instructions



Temposonics® R-Series

Brief Instructions

Table of contents

1. Introduction	3
2. Safety instructions	4
2.1 Intended use.....	4
2.2 Forseeable misuse.....	4
2.3 Installation, commissioning and operation.....	5
2.4 Safety instructions for use in explosion-hazardous areas.....	5
2.5 Warranty.....	5
2.6 Return.....	5
2.7 Maintenance & removal.....	5
3. Identification	6
3.1 Temposonics® R-Series RP.....	6
3.2 Temposonics® R-Series RH.....	6
3.3 Temposonics® R-Series RD4.....	7
3.4 Temposonics® R-Series RT4.....	7
3.5 Temposonics® R-Series RF.....	7
4. Installation & mounting	8
4.1 Magnet installation.....	8
4.2 Mounting dimensions of R-Series.....	9
4.3 Multi-position measurement distances.....	11
5. Electrical connections	12
5.1 Analog.....	13
5.2 SSI.....	13
5.3 Profibus.....	13
5.4 CANbus.....	14
5.5 DeviceNet.....	14
5.6 EtherCAT®.....	14
5.7 EtherNet/IP™.....	15
5.8 Powerlink.....	15
5.9 Profinet.....	15

1. Introduction

1.1 Purpose and use of this manual

Before starting the operation of Temposonics® sensors read this documentation thoroughly and follow the safety information. Keep the manual for future reference!

The content of this technical documentation is intended to provide information on mounting, installation and commissioning by qualified automation personnel¹ or instructed service technicians who are familiar with the project planning and dealing with Temposonics® sensors.

1.2 Used symbols and warnings

Warnings are intended for your personal safety and for avoidance of damage to the described product or connected devices. In this documentation, safety information and warnings to avoid danger that might affect the life and health of operating or service personnel or cause material damage are highlighted by the preceding pictogram, which is defined below.

Symbol	Meaning
NOTICE	This symbol is used to point to situations that may lead to material damage, but not to personal injury.

- 1/ The term qualified technical personnel characterizes persons who:
- are familiar with the safety concepts of automation technology applicable to the particular project,
 - are competent in the field of EMC,
 - have received adequate training for commissioning and service operations
 - are familiar with the operation of the device and know the information required for correct operation provided in the product documentation.

2. Safety instructions

2.1 Intended use

This product may be used only for the applications defined under item 1 only in conjunction with the third-party devices and components recommended or approved by MTS Sensors. As a prerequisite of proper and safe operation, the product requires correct transport, storage, mounting and commissioning and must be operated with utmost care.

1. The sensor systems of all Temposonics® series are intended exclusively for measurement tasks encountered in industrial, commercial and laboratory applications. The sensors are considered as system accessories and must be connected to suitable evaluation electronics, e.g. a PLC, IPC, indicator or other electronic control unit.

2.2 Forseeable misuse

Forseeable misuse	Consequence
Wrong sensor connection	The sensor does not work properly or will be destroyed
Operate the sensor out off the operating temperature	No signal output The sensor can be damaged
Power supply is out of the defined range	Signal output is wrong / no signal output / the sensor will be damaged
Position measurement is influenced by an external magnetic field	Signal output is wrong
Cables are damaged	Short circuit – the sensor can be destroyed / sensor does not respond
Spacers are missing / are installed in a wrong order	Error in position measurement
Wrong connection of ground / shield	Signal output is disturbed The electronics can be damaged
Use of a magnet that is not certified by MTS Sensors	Error in position measurement

Do not reprocess the sensor afterwards.
→ The sensor might be damaged.

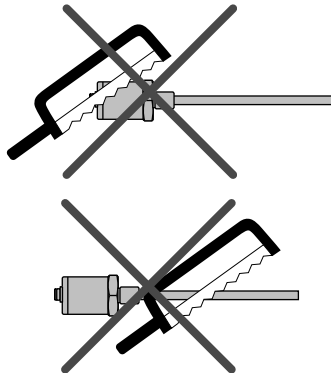

Do not step on the sensor.
→ The sensor might be damaged.

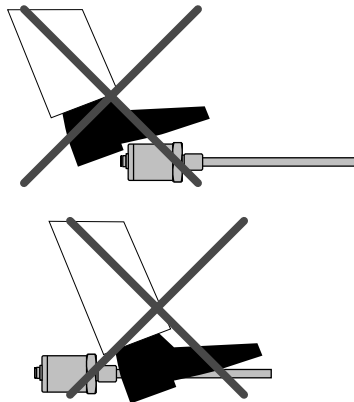

2.3 Installation, commissioning and operation

The position sensors must be used only in technically safe condition. To maintain this condition and to ensure safe operation, installation, connection and service, work may be performed only by qualified technical personnel.

If danger of injury to persons or of damage to operating equipment is caused by sensor failure or malfunction, additional safety measures such as plausibility checks, limit switches, EMERGENCY STOP systems, protective devices etc. are required. In the event of trouble, shut down the sensor and protect it against accidental operation.

Safety instructions for commissioning

To maintain the sensor operability, it is mandatory to follow the instructions given below.

1. Protect the sensor against mechanical damage during installation and operation.
2. Do not open or dismantle the sensor.
3. Connect the sensor very carefully and pay attention to the polarity of connections and power supply.
4. Use only approved power supplies.
5. It is indispensable to ensure that the specified permissible limit values of the sensor for operating voltage, environmental conditions, etc. are met.
6. Check the function of the sensor regularly and provide documentation of the checks.
7. Before system switch-on, ensure that nobody's safety is jeopardized by starting machines.

2.4 Safety instructions for use in explosion-hazardous areas

The sensors are not suitable for operation in explosion-hazardous areas.

2.5 Warranty

MTS Sensors grants a warranty² period for the Temposonics® position sensors and supplied accessories relating to material defects and faults that occur despite correct use in accordance with the intended application. The MTS Sensors obligation is limited to repair or replacement of any defective part of the unit. No warranty can be taken for defects that are due to improper use or above average stress of the product, as well as for wear parts. Under no circumstances will MTS Sensors accept liability in the event of offense against the warranty rules, no matter if these have been assured or expected, even in case of fault or negligence of the company.

MTS Sensors explicitly excludes any further warranties. Neither the company's representatives, agents, dealers nor employees are authorized to increase or change the scope of warranty.

2.6 Return

For diagnostic purposes, the sensor can be returned to MTS Sensor Technologie GmbH & Co. KG. Any shipment cost will be borne by the sender². For a corresponding form, see detailed operation manual (available at: www.mtssensors.com).

2.7 Maintenance & removal

Further information about maintenance and removal is provided in the sensor specific operation manuals.

^{2/} See also applicable MTS Sensors sales and supply conditions, e.g. under www.mtssensors.com



Tempsonics® R-Series

Brief Instructions

3. Identification

Nameplate (e.g. R-Series RH SSI)

Order code	RHM0425MD701S1G2100
Code output dependent	0.01 mm / 25 Bit gray Grd.: 2797.14 m/s
Serial no.	FNr.: 1413 3950



Approvals and certificates

You will find approvals and certificates in the sensor specific operation manuals.

3.1 Tempsonics® R-Series RP (profile housing)

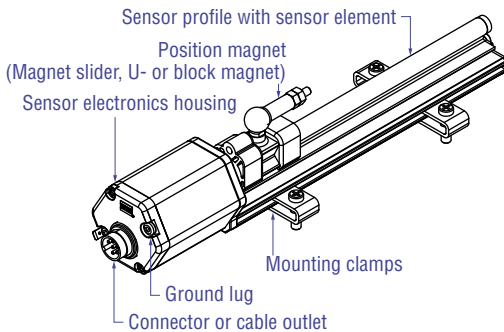

Available outputs:

- Analog
- SSI
- Profibus
- CANbus
- DeviceNet
- EtherCAT®
- EtherNet/IP™
- Powerlink
- Profinet

3.2 Tempsonics® R-Series RH (rod housing)

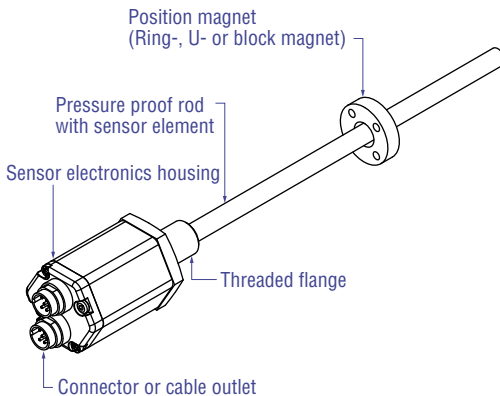

Available outputs:

- Analog
- SSI
- Profibus
- CANbus
- DeviceNet
- EtherCAT®
- EtherNet/IP™
- Powerlink
- Profinet

Manuals & Software available at:
www.mtsensors.com

3.3 Temposonics® R-Series RD4 (sensor rod with detached electronics)

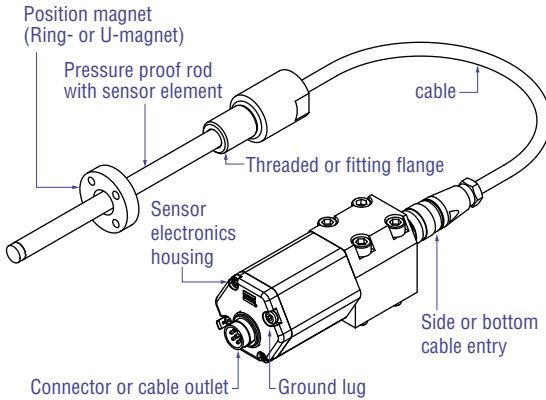

Available outputs:

- Analog
- SSI
- Profibus
- CANbus
- DeviceNet
- EtherCAT®
- EtherNet/IP™
- Powerlink
- Profinet

3.4 Temposonics® R-Series RT4 (sensor rod with redundant, detached electronics)

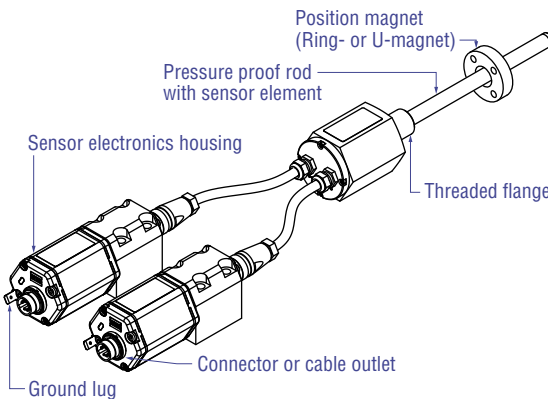

Available outputs:

- SSI

3.5 Temposonics® R-Series RF (flexible sensor rod)

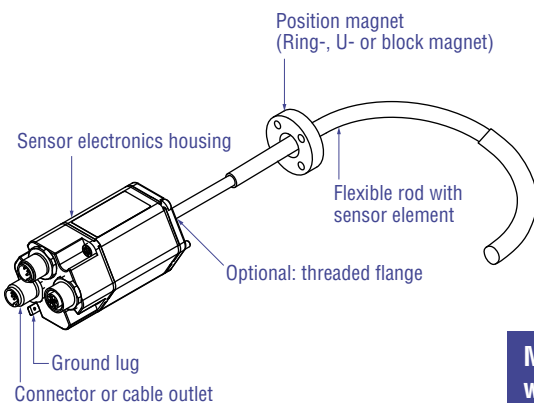





Available outputs:

- Analog
- SSI
- Profibus
- CANbus
- DeviceNet
- EtherCAT®
- EtherNet/IP™
- Powerlink
- Profinet

Manuals & Software available at:
www.mtssensors.com

4. Installation & mounting

Typical use of magnets	
	<p>For: RH, RD4, RT4 & RF</p> <ul style="list-style-type: none"> • Rotationally symmetrical magnetic field
Ring magnet	
	<p>For: RP, RH, RD4, RT4 & RF</p> <ul style="list-style-type: none"> • The magnet can be lifted off • Height tolerances can be compensated
U-magnet	
	<p>For: RP, RH & RF</p> <ul style="list-style-type: none"> • The magnet can be lifted off • Height tolerances can be compensated
Block magnet	
	<p>For: RP</p> <ul style="list-style-type: none"> • The magnet is guided through the profile • The distance between the magnet and the waveguide is strictly defined • Easy coupling via the ball joint
Magnet slider	

4.1 Magnet installation

Install the magnet using non-magnetic material for mounting device, screws, spacers etc.. The magnet must not grind on the sensor rod. Alignment errors are compensated via the air gap.

- Max. permissible surface pressure: 40 N/mm²
- Max. fastening torque for M4 screws: 1 Nm; use washers, if necessary

NOTICE

Mount the ring magnet and U-magnet concentrically. Mount the block magnet centrally.

The maximum permissible air gap must not be exceeded.

Take care to mount the sensor in an axially parallel position to avoid damage of the carriage, magnet and sensor rod.

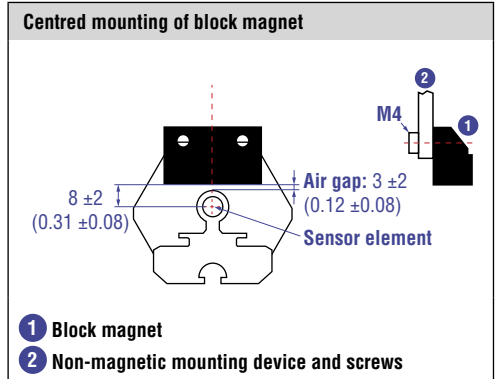

Magnet mounting with magnetic material
When using magnetic material the dimensions in the drawing beneath must be observed. If the position magnet set further into the piston rod install another non-magnetic spacer above the magnet.

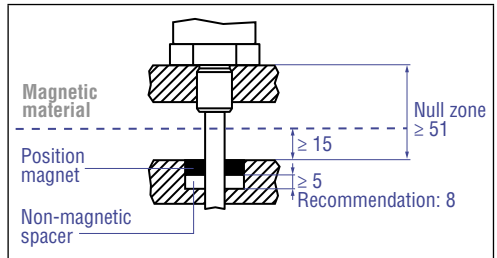

Horizontally installed sensor rods should be supported mechanically at the rod end. Without the use of a support, rod and position magnet may be damaged. A false measurement result is also possible. Longer rods require evenly distributed mechanical support over the entire length.

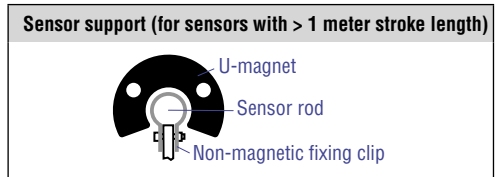
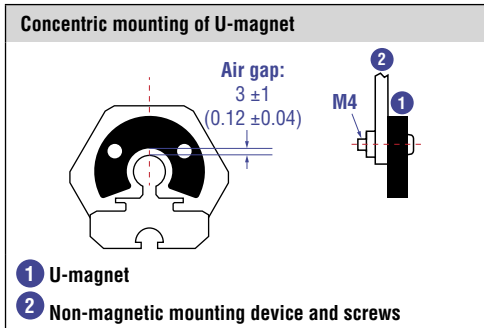

4.2 Mounting dimensions of R-Series

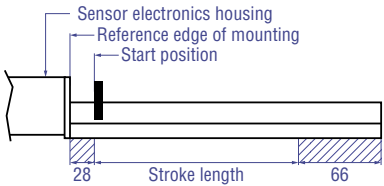
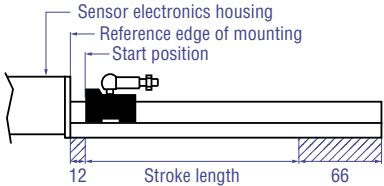
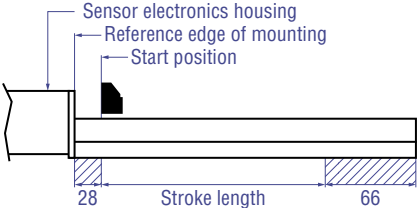
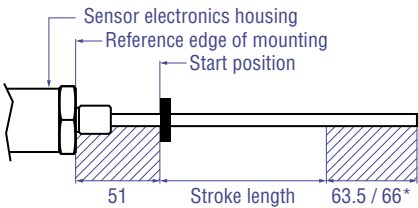
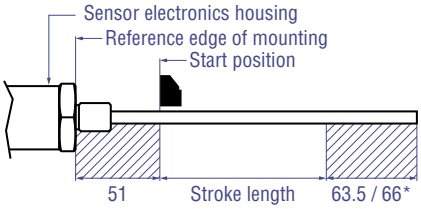
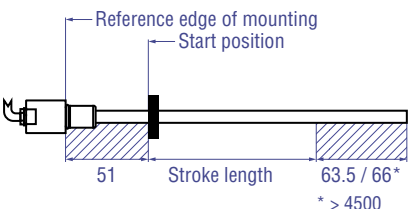
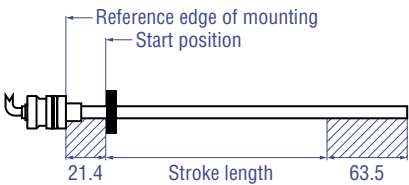
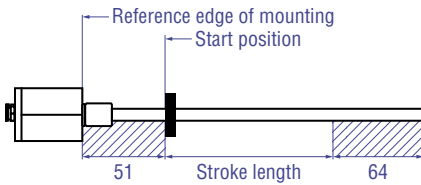
<p>R-Series RP with U-magnet</p>  <p>Sensor electronics housing Reference edge of mounting Start position</p> <p>28 Stroke length 66</p>	<p>R-Series RP with magnet slider »S«, »N«, »V«, »G«</p>  <p>Sensor electronics housing Reference edge of mounting Start position</p> <p>12 Stroke length 66</p>
<p>R-Series RP with block magnet</p>  <p>Sensor electronics housing Reference edge of mounting Start position</p> <p>28 Stroke length 66</p>	<p>R-Series RH with ring- /U-magnet</p>  <p>Sensor electronics housing Reference edge of mounting Start position</p> <p>51 Stroke length 63.5 / 66*</p> <p>* > 5000 stroke length</p>
<p>R-Series RH with block magnet</p>  <p>Sensor electronics housing Reference edge of mounting Start position</p> <p>51 Stroke length 63.5 / 66*</p> <p>* > 5000 stroke length</p>	<p>R-Series RD4-M /C with ring- /U-magnet</p>  <p>Reference edge of mounting Start position</p> <p>51 Stroke length 63.5 / 66*</p> <p>* > 4500 stroke length</p>
<p>R-Series RD4-S with Ring- /U-magnet</p>  <p>Reference edge of mounting Start position</p> <p>21.4 Stroke length 63.5</p>	<p>R-Series RT4-M /D /T with ring- /U-magnet</p>  <p>Reference edge of mounting Start position</p> <p>51 Stroke length 64</p>

Temposonics® R-Series

Brief Instructions

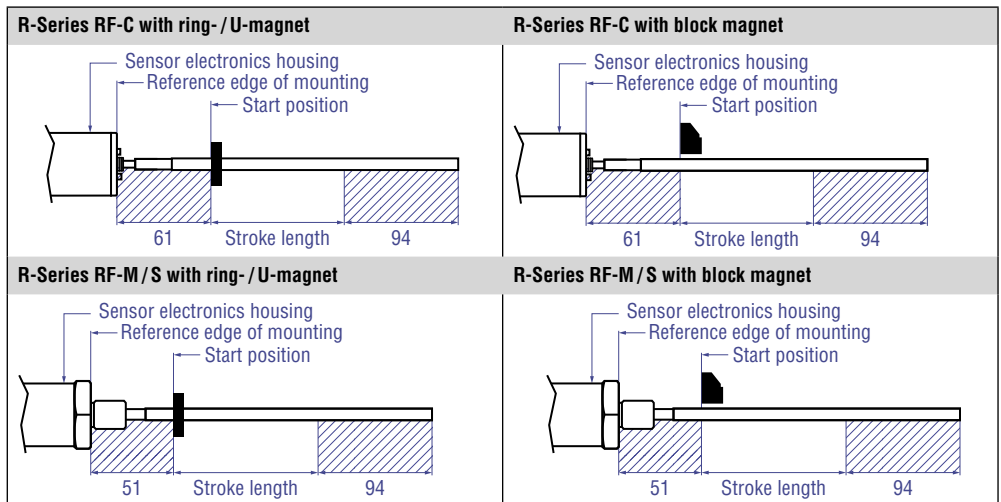

NOTICE

The operating position of the sensor is arbitrary.

4.3 Multi-position measurement distances

Multi-position measurements are output signal dependent possible.
The acquisition of up to 20 positions or 5 positions and their velocities.
Please note that the stroke length influences the maximum number of magnets.

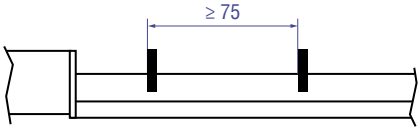
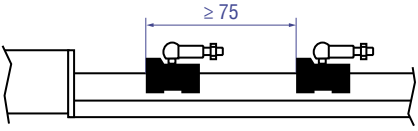
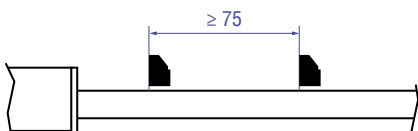
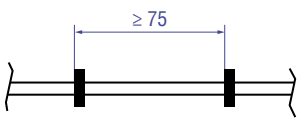
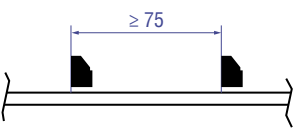
R-Series RP with U-magnets	R-Series RP with magnet sliders »S«, »N«, »V«, »G«
	
R-Series RP with block magnets	R-Series with sensor rods (RH/RD4/RF) with ring-/U-magnets
	
R-Series with sensor rods (RH/RF) with block magnets	
	

NOTICE

Use for multi-position measurement the same model for each magnet!

Temposonics® R-Series

Brief Instructions

5. Electrical connections

Placement of installation and cabling have decisive influence on the sensor EMC. Hence correct installation of this active electronic system and the EMC of the entire system must be ensured by using suitable metal connectors, shielded cables and grounding. Overvoltages or faulty connections can damage its electronics despite protection against wrong polarity.

NOTICE

Never connect / disconnect the sensor when voltage is applied.

Instructions for connection

- Use low-resistance twisted pair and shielded cables and connect the shield to ground externally via the controller equipment.
- Keep control and sign leads separate from power cables and sufficiently far away from motor cables, frequency inverters, valve lines, relays, etc.
- Use only connectors with metal housing and connect the shielding to the connector housing.
- Keep the connection surface at both shielding ends as large as possible.
- Keep all non-shielded leads as short as possible.
- Keep the earth connection as short as possible with a large cross section. Avoid ground loops.
- With potential differences between machine and electronics earth connections, no compensating currents are allowed to flow across the cable shielding.

Recommendation:

Install potential compensating leads with large cross section, or use cables with separate double shielding, and connect only one end of the shield.

- Use only stabilized power supplies in compliance with the specified connecting values.

NOTICE

Do not mount the sensors in the area of strong magnetic or electric noise fields. Sensors must be grounded on the ground lug on the sensor electronics housing.

Sensor grounding

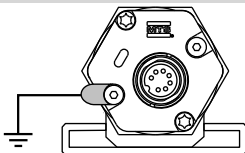

LED	Outputs
	<ul style="list-style-type: none"> • Analog • CANbus • EtherCAT® • SSI • Profibus • Profinet
	<ul style="list-style-type: none"> • EtherNet/IP™ • Powerlink
	<ul style="list-style-type: none"> • DeviceNet

Manuals & Software available at:
www.mtsensors.com

5.1 Analog

D60 / RXX / HXX

M16 connector	Output	Pin	Cable	Function
	1	1	GY	Position: Magnet 1
		2	PK	DC Ground
	2*	3	YE	Position: Magnet 2 or Velocity: Magnet 1
		4	GN	DC Ground
		5	BN	+24 VDC (-15 / +20 %)
		6	WH	DC Ground (0 V)

*order dependent

LED status

Green	Red		
● ON	○ OFF	Normal function	
● ON	● ON	No magnet / wrong quantity of magnets	
● ON	● Flashing	Magnet is not in the set range	
● Flashing	● ON	Programming mode	

NOTICE

Mind the hazard of short circuits!

When using only output 1, insulation of the yellow and green cores (output 2) is indispensable. Recommendation: Provide terminals for output 2 in the control cabinet, because the leads are eventually required in case of sensor programming.

5.2 SSI

D70 / PXX

M16 connector	Pin	Cable	Function
	1	GY	Data (-)
	2	PK	Data (+)
	3	YE	Clock (+)
	4	GN	Clock (-)
	5	BN	+24 VDC (-15 / +20 %)
	6	WH	DC Ground (0 V)
	7	-	-



LED status

Green	Red		
● ON	○ OFF	Normal function	
● ON	● ON	No magnet / wrong quantity of magnets	
● Flashing	● ON	Programming mode	
● ON	● Flashing	Sensor not synchronous*	

* for synchronous measurement only

5.3 Profibus

D53 / AXX



M12 B-coded	Pin	Cable	Function
	1	-	VP +5 VDC (for bus termination)*
	2	GN	RxD / TxD-N (bus)
	3	-	Data GND (for bus termination)*
	4	RD	RxD / TxD-P (bus)
	5	Shield	Shield

Operating voltage

M8 connector	Pin	Function
	1	+24 VDC (-15 / +20 %)
	2	-
	3	DC Ground (0 V)
	4	-

D63

*female insert only

M16 connector	Pin	Function
	1	RxD / TxD-N (bus)
	2	RxD / TxD-P (bus)
	3	Data GND (terminal resistor)*
	4	VP +5 VDC (terminal resistor)*
	5	+24 VDC (-15 / +20 %)
	6	DC Ground (0 V)
		

*female insert only

LED status

Green	Red		
● ON	○ OFF	Normal function	
● ON	● ON	No magnet / wrong quantity of magnets	
● Flashing	○ OFF	Waiting for master parameters	
● Flashing	● ON	Programming mode	

NOTICE

- Use only bus cables, according to regulations of the Profibus User Organisation (www.profibus.com).
- Bus lines must be installed according to Profibus guideline.
- Bus wiring must be terminated at both ends.

Manuals & Software available at:
www.mtssensors.com

Temposonics® R-Series

Brief Instructions

5.4 CANbus

D54 (BUS In/Out)

M12 A-coded	Pin	Function
	1	Shield
	2	-
	3	-
	4	CAN_H
	5	CAN_L

	1	-
	2	-
	3	-

Operating voltage

M8 connector	Pin	Function
	1	+24 VDC (-15 / +20 %)
	2	-
	3	DC Ground (0 V)
	4	-

D60 / D62 (BUS In/Out) / PXX

M16 connector	Pin	Cable	Function
	1	GY	CAN_L
	2	PK	CAN_H
	3	YE	-
	4	GN	-
	5	BN	+24 VDC (-15 / +20 %)
	6	WH	DC Ground (0 V)

D55 (BUS In/Out)

M12 connector	Pin	Function
	1	Shield
	2	+24 VDC (-15 / +20 %)
	3	DC Ground (0 V)
	4	CAN_H
	5	CAN_L

	1	-
	2	-
	3	-

LED status

Green	Red	Function
● ON	○ OFF	Normal function
● ON	● ON	No magnet / wrong quantity of magnets
○ OFF	● ON	Initialization error
● Flashing	● Flashing	Operating voltage out of range

5.5 DeviceNet

D51

M12 connector	Pin	Function
	1	Shield
	2	+24 VDC (-15 / +20 %)
	3	DC Ground (0 V)
	4	CAN_H
	5	CAN_L

LED status

Green	Red	Function
● ON	○ OFF	Normal function
● Flashing	○ OFF	Waiting for instructions from DeviceNet master
○ OFF	● ON	Initialization error
○ OFF	● Flashing	No answer from DeviceNet master

Modul status	Function	
● ON	○ OFF	Normal function
○ OFF	● ON	Magnet not detected

5.6 EtherCAT®

D56 (BUS In/Out)

M12 D-coded	Pin	Function
	1	Tx (+)
	2	Rx (+)
	3	Tx (-)
	4	Rx (-)

Operating voltage

M8 connector	Pin	Function
	1	+24 VDC (-15 / +20 %)
	2	-
	3	DC Ground (0 V)
	4	-

LED status





Green	Red	Function
● Flashing	○ OFF	Normal function
● Flashing	● ON	No magnet / wrong quantity of magnets

Further diagnostic functions can be programmed.





Manuals & Software available at:
www.mtssensors.com

5.7 EtherNet/IP™

D56 (BUS In/Out)

M12 D-coded	Pin	Function
	1	Tx (+)
	2	Rx (+)
	3	Tx (-)
	4	Rx (-)

Operating voltage

M8 connector	Pin	Function
	1	+24 VDC (-15 / +20 %)
	2	Used for DHCP reset only*
	3	DC Ground (0 V)
	4	Used for DHCP reset only*





* They should be independent of each other and floating (not grounded) under normal operation.

LED Status





Green	Red		
Network status			
		OFF	Connection established
		OFF	No connection
		ON	Unrecoverable error
		Flashing	Recoverable error
Port 1 (IN)			
		OFF	LINK activity on port 1
		OFF	Data transfer on port 1
		ON	No magnet / wrong quantity of magnets
Port 2 (OUT)			
		OFF	LINK activity on port 2
		OFF	Data transfer on port 2
Module status			
		OFF	IP address configured
		OFF	IP address not configured
		Flashing	Duplicate of IP address recognized

5.8 Powerlink

D56 (BUS In/Out)

M12 D-coded	Pin	Function
	1	Tx (+)
	2	Rx (+)
	3	Tx (-)
	4	Rx (-)

Operating voltage





M8 connector	Pin	Function
	1	+24 VDC (-15 / +20 %)
	2	-
	3	DC Ground (0 V)
	4	-

LED status





Green	Red		
Bus status			
		OFF	Connection established
Port 1			
		OFF	LINK activity on port 1
		OFF	Data activity on port 1
		ON	Missing magnet
Port 2			
		OFF	LINK activity on port 2
		OFF	Data activity on port 2
Bus error			
		ON	Fault detected

5.9 Profinet

D58 (BUS In/Out)

M12 D-coded	Pin	Function
	1	Tx (+)
	2	Rx (+)
	3	Tx (-)
	4	Rx (-)

Operating voltage

M12 A-coded	Pin	Function
	1	+24 VDC (-15 / 20 %)
	2	Do not connect!*
	3	DC Ground (0 V)
	4	Do not connect!*

*As a connection to this pin may influence the correct startup of the sensor

LED Status

Green	Red		
		OFF	Normal function
		ON	No connection to master
		Flashing	Parameterization failed
		ON	Warning! (illegal supply voltage / wrong quantity of magnets)

Manuals & Software available at:
www.mtssensors.com

Document Part Number:
551516 Revision E (EN) 01/2016

LOCATIONS

USA

**MTS Systems Corporation
Sensors Division**
3001 Sheldon Drive
Cary, N.C. 27513, USA
Tel. +1 919 677-0100
Fax +1 919 677-0200
info.us@mtssensors.com
www.mtssensors.com

JAPAN

MTS Sensors Technology Corp.
737 Aihara-machi,
Machida-shi,
Tokyo 194-0211, Japan
Tel. +81 42 775-3838
Fax +81 42 775-5512
info.jp@mtssensors.com
www.mtssensors.com

FRANCE

MTS Systems SAS
Zone EUROPARC Bâtiment EXA 16
16/18, rue Eugène Dupuis
94046 Creteil, Frankreich
Tel. +33 1 58 4390-28
Fax +33 1 58 4390-03
info.fr@mtssensors.com
www.mtssensors.com

GERMANY

**MTS Sensor Technologie
GmbH & Co. KG**
Auf dem Schüffel 9
58513 Lüdenscheid, Germany
Tel. +49 2351 9587-0
Fax +49 2351 56491
info.de@mtssensors.com
www.mtssensors.com

CHINA

MTS Sensors
Room 504, Huajing Commercial Center,
No. 188, North Qinzhou Road
200233 Shanghai, China
Tel. +86 21 6485 5800
Fax +86 21 6495 6329
info.cn@mtssensors.com
www.mtssensors.com

ITALY

MTS Systems Srl.
Sensor Division
Via Diaz,4
25050 Provaglio d'Iseo (BS), Italien
Tel. +39 030 988 3819
Fax +39 030 982 3359
info.it@mtssensors.com
www.mtssensors.com

LEGAL NOTICES

MTS, Temposonics and Level Plus are registered trademarks of MTS Systems Corporation in the United States; MTS SENSORS and the MTS SENSORS logo are trademarks of MTS Systems Corporation within the United States. These trademarks may be protected in other countries. All other trademarks are the property of their respective owners. Copyright © 2015 MTS Systems Corporation. No license of any intellectual property rights is granted. MTS reserves the right to change the information within this document, change product designs, or withdraw products from availability for purchase without notice. Typographic and graphics errors or omissions are unintentional and subject to correction. Visit www.mtssensors.com for the latest product information.

ISO 9001
CERTIFIED



Reg.-No. 003095-QM08