

Temposonics®

Magnetostrictive Linear Position Sensors



Sensor with Ex approval

ET Start/Stop ATEX / IECEx / CEC / NEC Certified
Operation Manual



Table of contents

1. Introduction	3
1.1 Purpose and use of this manual	3
1.2 Used symbols and warnings	3
2. Safety instructions	3
2.1 Intended use	3
2.2 Foreseeable misuse	3
2.3 Installation, commissioning and operation	4
2.4 Safety instructions for use in explosion-hazardous areas	5
2.5 Warranty	5
2.6 Return	5
3. Identification	6
3.1 Order code Temposonics® ET	6
3.2 Nameplate (example)	7
3.3 Approvals	7
3.4 Scope of delivery	7
4. Product description and commissioning	7
4.1 Functionality and system design	7
4.2 Styles and installation of Temposonics® ET	8
4.3 Magnet installation	10
4.4 Electrical connection	11
4.5 Frequently ordered accessories	12
5. Operation	14
5.1 Getting started	14
5.2 Programming and configuration	14
6. Maintenance and troubleshooting	16
6.1 Error conditions, troubleshooting	16
6.2 Maintenance	16
6.3 Repair	16
6.4 List of spare parts	16
6.5 Transport and storage	16
7. Removal from service / dismantling	16
8. Technical data of Temposonics® ET	17
9. Appendix	19
10. Declaration of conformity	20

1. Introduction

1.1 Purpose and use of this manual

Before starting the operation of Temposonics® position sensors read this documentation thoroughly and follow the safety information. Keep the manual for future reference!

The content of this technical documentation and of its appendix is intended to provide information on mounting, installation and commissioning by qualified automation personnel ¹ or instructed service technicians who are familiar with the project planning and dealing with Temposonics® sensors.

1.2 Used symbols and warnings

Warnings are intended for your personal safety and for avoidance of damage to the described product or connected devices. In this documentation, safety information and warnings to avoid danger that might affect the life and health of operating as well as service personnel or cause material damage are highlighted by the preceding pictogram, which is defined below.

Symbol	Meaning
NOTICE	This symbol is used to point to situations that may lead to material damage, but not to personal injury.

2. Safety instructions

2.1 Intended use

This product may be used only for the applications defined under item 1 to item 4 and only in conjunction with the third-party devices and components recommended or approved by MTS Sensors. As a prerequisite of proper and safe operation, the product requires correct transport, storage, mounting and commissioning and must be operated with utmost care.

1. The sensor systems of all Temposonics® series are intended exclusively for measurement tasks encountered in industrial, commercial and laboratory applications. The sensors are considered as system accessories and must be connected to suitable evaluation electronics, e.g. a PLC, IPC, indicator or other electronic control unit.
2. The sensor's surface temperature class is T4.
3. The ATEX, IECEx, NEC and CEC certificates have to be taken into account, including any special conditions defined therein, as well as chapter "2.3 Installation, commissioning and operation" on page 4.

^{1/} The term qualified technical personnel characterizes persons who:

- are familiar with the safety concepts of automation technology applicable to the particular project
- are competent in the field of electromagnetic compatibility (EMC)

4. The position sensor may be used in hazardous areas according to Fig. 23. Any use of this product outside of these approved areas will void the warranty and all manufacturer's product responsibilities and liabilities. For non-hazardous areas MTS Sensors recommends to use the version N (not approved).

Zone	Explosion group
Zone 2 (Gas-Ex, category 3G, EPL Gc)	IIA, IIB and IIC
Zone 22 (Dust-Ex, category 3D, EPL Dc)	IIIA, IIIB and IIIC

Class	Group
Class I (Gas, Division 2)	A, B, C, D
Class II / III (Dust, Division 2)	F, G

2.2 Forseeable misuse

Forseeable misuse	Consequence
Lead compensating currents through the enclosure	The sensor will be damaged
Wrong sensor connection	The sensor will not work properly or will be destroyed
Operate the sensor out of the operating temperature range	No signal output The sensor can be damaged
Power supply is out of the defined range	Signal output is wrong / no signal output / the sensor will be damaged
Position measurement is influenced by an external magnetic field	Signal output is wrong
Cables are damaged	Short circuit – the sensor can be destroyed / sensor does not respond
Spacers are missing / are installed in a wrong order	Error in position measurement
Wrong connection of ground / shield	Signal output is disturbed The electronics can be damaged
Use of a magnet that is not certified by MTS Sensors	Error in position measurement
Wrong gradient in controller	Error in position measurement

- have received adequate training for commissioning and service operations
- are familiar with the operation of the device and know the information required for correct operation provided in the product documentation

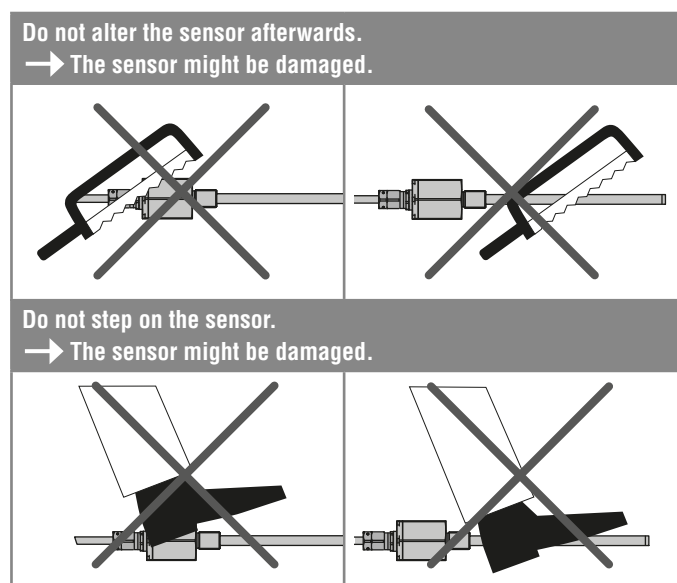

2.3 Installation, commissioning and operation

The position sensors must be used only in technically safe condition. To maintain this condition and to ensure safe operation, installation, connection and service, work may be performed only by qualified technical personnel, according to IEC 60079-14, IEC 60079-17, TRBS 1203, Canadian Electrical Code (CEC), National Electrical Code (NEC) and local regulations.

If danger of injury to persons or of damage to operating equipment is caused by sensor failure or malfunction, additional safety measures such as plausibility checks, limit switches, EMERGENCY STOP systems, protective devices etc. are required. In the event of trouble, shut down the sensor and protect it against accidental operation.

Safety instructions for commissioning

To maintain the sensor's operability, it is mandatory to follow the instructions given below.

1. Follow the specifications given in the technical data.
2. Ensure that equipment and associated components used in a hazardous environment are selected and installed in compliance with regulations governing the geographical location and facility. Only install equipment that complies with the types of protection relevant to the applicable Zones and Categories.
3. In explosive atmospheres use only such auxiliary components that meet all requirements of the local and national standards.
4. The potential equalisation of the system has to be established according to the regulations of erection applicable in the respective country of use (VDE 0100, part 540; IEC 364-5-54).
5. Sensors from MTS Sensors are approved only for the intended use in industrial environments (see chapter "2.1 Intended use" on page 3). Contact the manufacturer for advice, if aggressive substances are present in the sensor environment.
6. Measures for lightning protection have to be taken by the user.
7. The user is responsible for the mechanical protection of the sensor.

8. The cable gland of the sensor must be protected against any external impact energy exceeding 4 J. The maximum thermal load of the cables must be taken into account.
9. The user is responsible for meeting all safety conditions as outlined by:
 - Installation instructions
 - Local prevailing standards and regulations
10. Any parts of the equipment which got stuck (e.g. by frost or corrosion) may not be removed by force if potentially explosive atmosphere is present.
11. The formation of ice on the equipment has to be prevented.
12. It is not allowed to open the sensor.
13. The connecting cable has to be either led out of the hazardous area uncut or wired to outlets which comply with the type of protection required locally.
14. The surface temperatures of equipment parts must be kept clearly below the ignition temperature of the foreseeable air / dust mixtures in order to prevent the ignition of suspended dust.

How to ensure safe commissioning

1. Protect the sensor against mechanical damage during installation and operation.
2. Do not use damaged products and secure them against unintentional commissioning. Mark damaged products as being defective.
3. Prevent electrostatic charges.
4. Do not use the sensor in cathodic systems for corrosion protection. Do not led parasitic currents via the construction.
5. Switch off the supply voltage prior to disconnecting or connecting the equipment.
6. Connect the sensor very carefully and pay attention to the polarity of connections, power supply as well as to the shape and duration of control pulses.
7. Use only approved power supplies.
8. Ensure that the specified permissible limit values of the sensor for supply voltage, environmental conditions, etc. are met.
9. Make sure that:
 - the sensor and associated components were installed according to the instructions
 - the sensor enclosure is clean
 - the magnet does not grind on the rod. This could cause damage to the magnet and the sensor rod. If there is contact between the moving magnet including the magnet holder and the sensor rod, make sure that the maximal speed of the moving magnet is less or equal 1 m/s.
10. Ground the sensor via the ground lug. Both the sensor and the moving magnet including magnet holder must be connected to protective ground (PE) to avoid electrostatic discharge (ESD).
11. Before applying power, ensure that nobody's safety is jeopardized by starting machines.
12. Check the function of the sensor regularly and provide documentation of the checks.
(see chapter "6.2 Maintenance" on page 16).

2.4 Safety instructions for use in explosion-hazardous areas

The sensor has been designed for operation inside explosion-hazardous areas. It has been tested and left the factory in a condition in which it is safe to operate. Relevant regulations and European standards as well as Canadian and North American standards have been observed. According to Ex marking (see chapter “2.1 Intended use” on page 3) and the ATEX, IECEx, NEC and CEC certificates (attached to this document), the sensor is approved only for operation in defined hazardous areas.

2.5 Warranty

MTS Sensors grants a warranty period for the Temposonics® position sensors and supplied accessories relating to material defects and faults that occur despite correct use in accordance with the intended application². The MTS Sensors obligation is limited to repair or replacement of any defective part of the unit. No warranty can be provided for defects that are due to improper use or above average stress of the product, as well as for wear parts. Under no circumstances will MTS Sensors accept liability in the event of offense against the warranty rules, no matter if these have been assured or expected, even in case of fault or negligence of the company. MTS Sensors explicitly excludes any further warranties. Neither the company's representatives, agents, dealers nor employees are authorized to increase or change the scope of warranty.

2.6 Return

For diagnostic purposes, the sensor can be returned to MTS Sensors. Any shipment cost is the responsibility of the sender². For a corresponding form, see chapter “9. Appendix” on page 19.

^{2/} See also applicable MTS Sensors terms of sales and delivery on www.mtssensors.com

3. Identification

3.1 Order code Temposonics® ET

1	2	3	4	5	6	7	8	9	10	11	12	13	14	15
E	T										1		R	3
a		b	c					d			e	f	g	

a	Sensor model
E T	Rod

b	Design
ET rod-style sensor with housing and sensor rod material stainless steel 1.4404 (AISI 316L)	
F	Threaded flange ¾"-16 UNF-3A
W	Threaded flange M18×1.5-6g
ET rod-style sensor with housing material stainless steel 1.4305 (AISI 303) and sensor rod material stainless steel 1.4306 (AISI 304L)	
M	Threaded flange M18×1.5-6g
S	Threaded flange ¾"-16 UNF-3A

c	Stroke length
X X X X M	0050...3000 mm
Standard stroke length (mm)* Ordering steps	
50 ... 500 mm	5 mm
500 ... 750 mm	10 mm
750...1000 mm	25 mm
1000...2500 mm	50 mm
2500...3000 mm	100 mm
X X X X U	002.0...118.0 in.
Standard stroke length (in.)* Ordering steps	
2 ... 20 in.	0.2 in.
20 ... 30 in.	0.5 in.
30 ... 40 in.	1.0 in.
40...100 in.	2.0 in.
100...116 in.	4.0 in.

d	Connection type
T X X	T01...T10 (1...10 m) ³ XX m Teflon® cable (part no. 530 112) T03...T33 (3...33 ft) ³ XX ft Teflon® cable (part no. 530 112)
V X X	V01...V10 (1...10 m) ³ XX m silicone cable (part no. 530 113) V03...V33 (3...33 ft) ³ XX ft silicone cable (part no. 530 113)

e	Operating voltage
1	+24 VDC (-15 / +20 %)

f	Version (see "Certification of Temposonics® ET (version A and E)" on page 18 for further information)
A	ATEX / IECEx / CEC / NEC
E	ATEX / IECEx / CEC / NEC with ½" NPT adapter
N	Not approved

NOTICE

Version E (section **f**) is only available with design (section **b**) »M« and »S«.

g	Output
R 3	Start/Stop with sensor parameters upload function

*/ Non standard stroke lengths are available; must be encoded in 5 mm / 0.1 in. increments

3/ Encode in meters if using metric stroke length. Encode in feet if using US customary stroke length

3.2 Nameplate (example)



Fig. 1: Label of sensor for use in explosion hazardous areas



Fig. 2: Label of sensor without certification for use in explosion hazardous areas

3.3 Approvals

See chapter “8. Technical data of Temposonics® ET” on page 17 f.

3.4 Scope of delivery

ET (rod sensor):

- Sensor

4. Product description and commissioning

4.1 Functionality and system design

Product designation

- Position sensor Temposonics® E-Series

Sensor model

- Temposonics® ET (rod sensor)

Stroke length

- 50...3000 mm (2...118 in.)

Output signal

- Start/Stop

Application

Temposonics® position sensors are used for measurement and conversion of the length (position) variable in the fields of automated systems and mechanical engineering.

Principle of operation and system construction

The absolute, linear position sensors provided by MTS Sensors rely on the company's proprietary Temposonics® magnetostrictive technology, which can determine position with a high level of precision and robustness. Each Temposonics® position sensor consists of a ferromagnetic waveguide, a position magnet, a strain pulse converter and supporting electronics. The magnet, connected to the object in motion in the application, generates a magnetic field at its location on the waveguide. A short current pulse is applied to the waveguide. This creates a momentary radial magnetic field and torsional strain on the waveguide. The momentary interaction of the magnetic fields releases a torsional strain pulse that propagates the length of the waveguide. When the ultrasonic wave reaches the end of

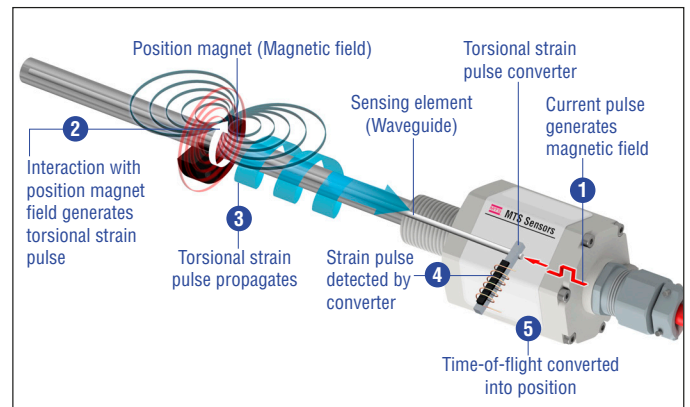

Fig. 3: Time-of-flight based magnetostrictive position sensing principle

the waveguide it is converted into an electrical signal. Since the speed of the ultrasonic wave in the waveguide is precisely known, the time required to receive the return signal can be converted into a linear position measurement with both high accuracy and repeatability.

Modular mechanical and electronic construction

- The sensor rod protects the inner sensor element.
- The sensor electronics housing, a rugged stainless steel construction, contains the complete electronic interface with active signal conditioning.
- The external position magnet is a permanent magnet. Mounted on the mobile machine part, it travels along the sensor rod and triggers the measurement through the sensor rod wall.
- The sensor can be connected directly to a control system. Its electronics generates a strictly position proportional signal output between start and end position.

4.2 Styles and installation of Temposonics® ET

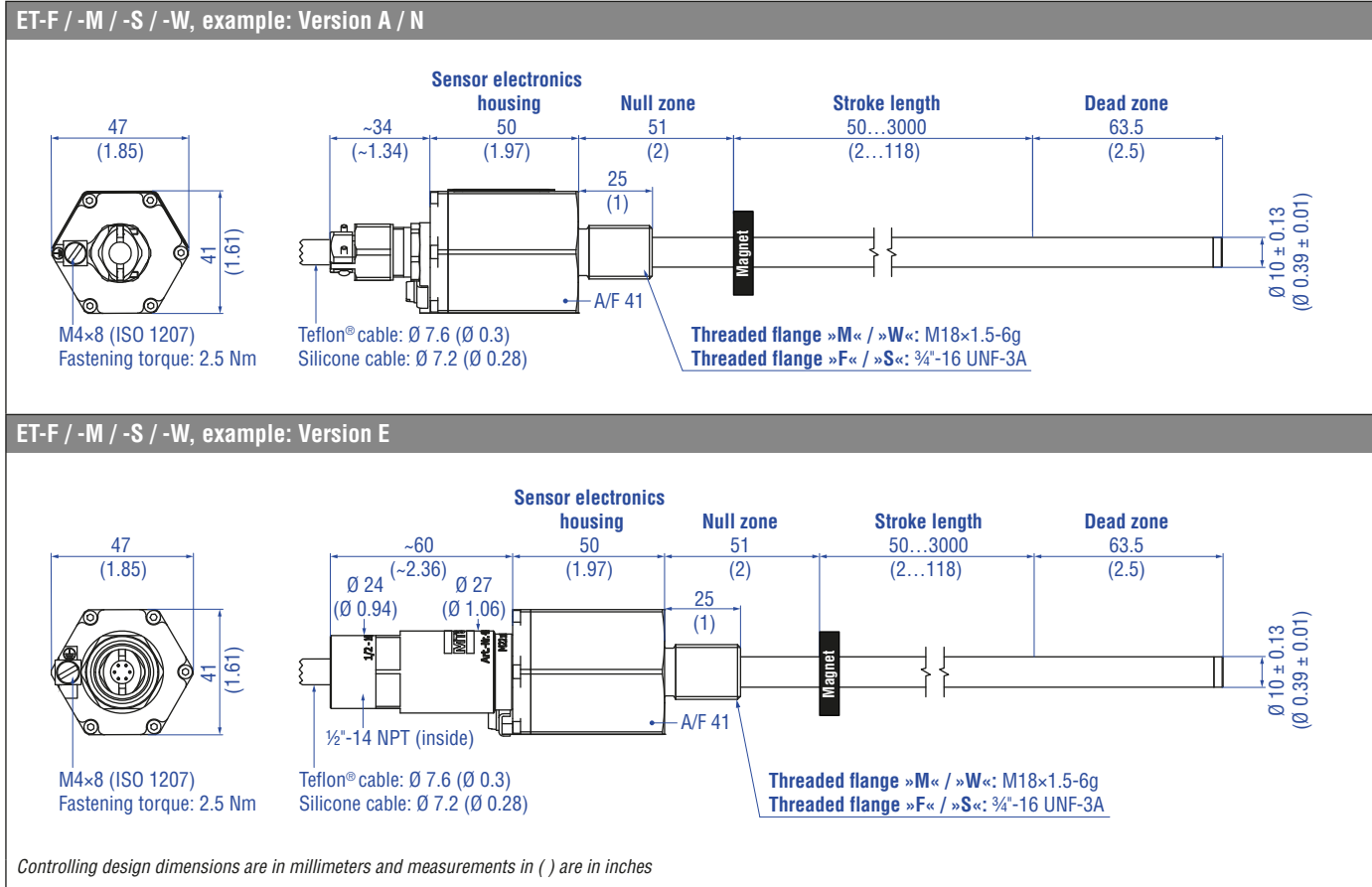

Fig. 4: Temposonics® ET with ring magnet

Installation of ET with threaded flange »F«, »M«, »S« & »W«

Fix the sensor rod via threaded flange M18x1.5-6g or 3/4"-16 UNF-3A.

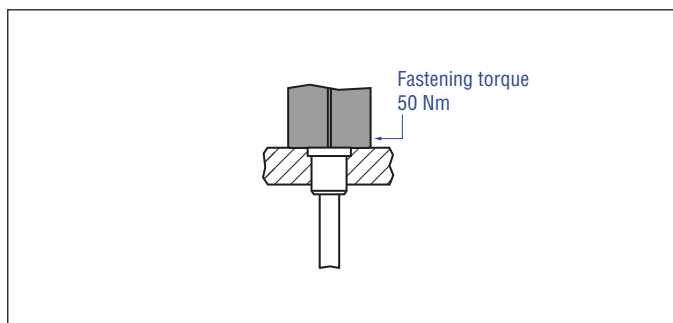

Fig. 5: Mounting example of threaded flange »F«, »M«, »S«, »W«

Installation of a rod-style sensor in a fluid cylinder

The rod-style version has been developed for direct stroke measurement in a fluid cylinder. Mount the sensor via threaded flange or a hex nut.

- Mounted on the face of the piston, the position magnet travels over the rod without touching it and indicates the exact position through the rod wall – independent of the hydraulic fluid.
- The pressure resistant sensor rod is installed into a bore in the piston rod.

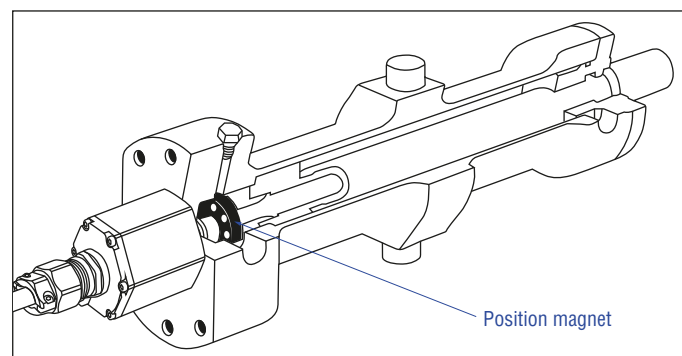

Fig. 6: Sensor in cylinder

Hydraulics sealing

There are two ways to seal the flange contact surface (Fig. 7):

1. A sealing by using an O-ring (e.g. 22.4 × 2.65 mm (0.88 × 0.1 in.), 25.07 × 2.62 mm (0.99 × 0.1 in.)) in a cylinder end cap groove.

2. A sealing by using an O-ring in the undercut.

For threaded flange (3/4"-16 UNF-3A) »F« / »S«:

O-ring 16.4 × 2.2 mm (0.65 × 0.09 in.) (part no. 560 315)

For threaded flange (M18×1.5-6g) »M« / »W«:

O-ring 15.3 × 2.2 mm (0.60 × 0.09 in.) (part no. 401 133)

In the case of threaded flange M18×1.5-6g provide a screw hole based on ISO 6149-1 (Fig. 8). See ISO 6149-1 for further information.

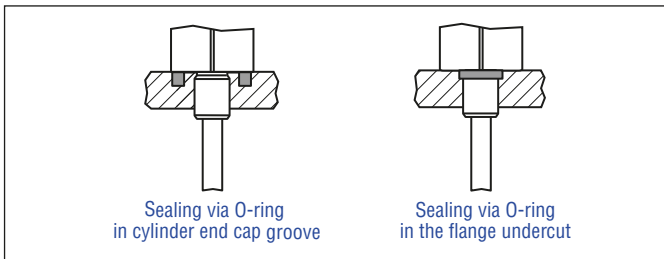

Fig. 7: Possibilities of sealing

- Note the fastening torque of 50 Nm.
- Seat the flange contact surface completely on the cylinder mounting surface.
- The cylinder manufacturer determines the pressure-resistant gasket (copper gasket, O-ring, etc.).
- The position magnet should not grind on the sensor rod.
- The piston rod drilling ($\geq \varnothing 13$ mm ($\geq \varnothing 0.51$ in.)) depends on the pressure and piston speed.
- Adhere to the information relating to operating pressure.
- Protect the sensor rod against wear.

Notice for metric threaded flanges

Thread ($d_1 \times P$)	d_2	d_3	d_4	d_5 +0.1 0	L_1 +0.4 0	L_2	L_3	L_4	Z° $\pm 1^\circ$
M18×1.5-6g	55	≥ 13	24.5	19.8	2.4	28	2	≥ 25.5	15°

All dimensions in mm

Fig. 8: Notice for metric threaded flange M18×1.5-6g based on DIN ISO 6149-1

4.3 Magnet installation

Typical use of magnets



Magnet	Benefits
Ring magnets 	<ul style="list-style-type: none"> Rotationally symmetrical magnetic field
U-magnets 	<ul style="list-style-type: none"> Height tolerances can be compensated

Fig. 9: Typical use of magnets

Mounting ring magnets & U-magnets

Install the magnet using non-magnetic material for mounting device, screws, spacers etc.. The magnet must not grind on the sensor rod. Alignment errors are compensated via the air gap.

- Permissible surface pressure: Max. 40 N/mm²
- Fastening torque for M4 screws: 1 Nm; use washers, if necessary
- Minimum distance between position magnet and any magnetic material has to be 15 mm (0.6 in.) (Fig. 11).
- If no other option exists and magnetic material is used, observe the specified dimensions (Fig. 11).

NOTICE

Mount ring magnets and U-magnets concentrically.
Do not exceed the maximum acceptable gap (Fig. 10).

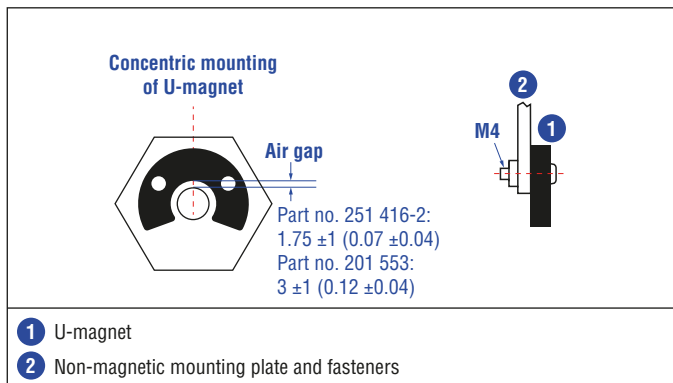

Fig. 10: Mounting of U-magnet (part no. 251 416-2 or part no. 201 553)

Magnet mounting with magnetic material

When using magnetic material the dimensions of Fig. 11 must be observed.

- If the position magnet aligns with the drilled piston rod
- If the position magnet is set further into the drilled piston rod, install another non-magnetic spacer (e.g. part no. 400 633) above the magnet.

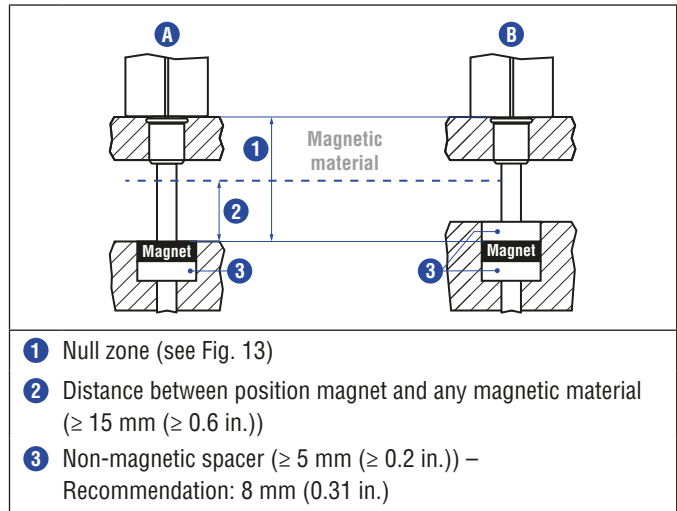

Fig. 11: Installation with magnetic material

Sensors with stroke lengths ≥ 1 meter (3.3 ft.)

Support horizontally installed sensors with a stroke length from 1 meter (3.3 ft.) mechanically at the rod end. Without the use of a support, rod and position magnet may be damaged. A false measurement result is also possible. Longer rods require evenly distributed mechanical support over the entire length (e.g. part no. 561 481). Use an U-magnet (Fig. 12) for measurement.

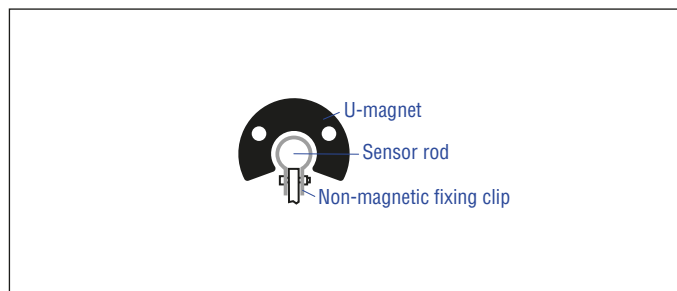

Fig. 12: Example of sensor support (part no. 561 481)

Start and end positions of the position magnets

Consider the start and end positions of the position magnets during the installation. To ensure that the entire stroke length is electrically usable, the position magnet must be mechanically mounted as follows.

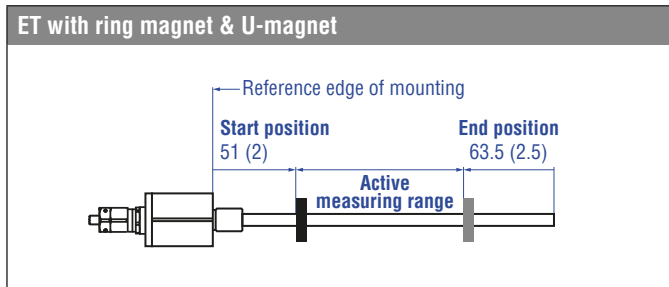

Fig. 13: Start and end positions of magnets

NOTICE

On all sensors, the areas left and right of the active stroke length are provided for null and dead zone (see “4.2 Styles and installation of Temposonics® ET” on page 8). These zones should not be used for measurement, however the active stroke length can be exceeded.

4.4 Electrical connection

Placement of installation and cabling have decisive influence on the sensor's electromagnetic compatibility (EMC). Hence correct installation of this active electronic system and the EMC of the entire system must be ensured by using suitable metal connectors, shielded cables and grounding. Overvoltages or faulty connections can damage the sensor electronics despite protection against wrong polarity.

NOTICE

1. Do not mount the sensors in the area of strong magnetic or electric noise fields.
2. Never connect / disconnect the sensor when voltage is applied.

Instruction for connection

- Connect the shield to ground externally via the controller equipment.
- Keep control and signal leads separate from power cables and sufficiently far away from motor cables, frequency inverters, valve lines, relays, etc..
- Use only connectors with metal housing, if you use a connector. Connect the shielding to the connector housing.
- Keep all non-shielded leads as short as possible.
- Keep the earth connection as short as possible with a large cross section. Avoid ground loops.
- With potential differences between machine and electronics earth connections, no compensating currents are allowed to flow across the cable shielding.

Recommendation:

- Install potential compensating leads with large cross section.
- Use only stabilized power supplies in compliance with the specified electrical ratings.

Grounding of rod sensors

Connect the sensor electronics housing to machine ground. Ground sensor type ET version A (with ATEX / IECEx / CEC / NEC approval) via ground lug as shown in Fig. 14. Ground the sensor type ET version N (not approved) via ground lug as shown in Fig. 14 or via thread. Ground sensor type ET version E (with ATEX / IECEx / CEC / NEC approval) via ground lug as shown in Fig. 15.

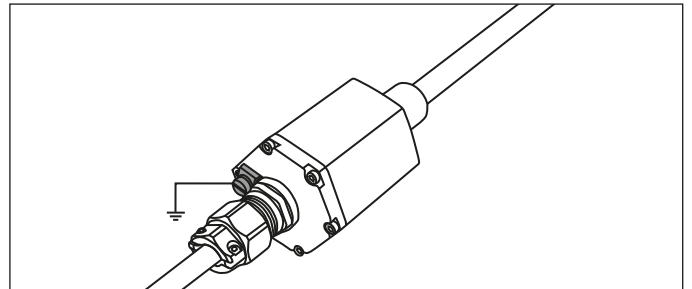

Fig. 14: Grounding via ground lug (version A, N)

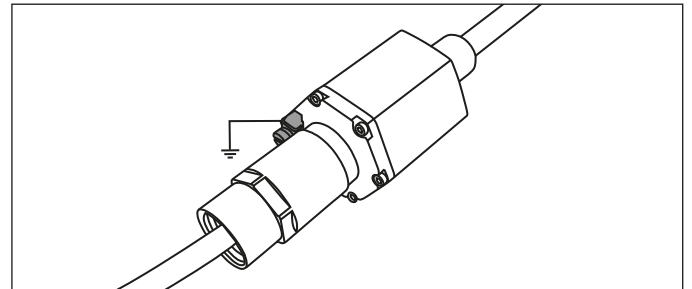

Fig. 15: Grounding via ground lug (version E)

Connector wiring

Connect the sensor directly to the controller, indicator or other evaluating systems as follows:

TXX / VXX		
Signal + power supply		
Cable	Color	Function
	GY	Stop (-)
	PK	Stop (+)
	YE	Start (+)
	GN	Start (-)
	BN	+24 VDC (-15 / +20 %)
	WH	DC Ground (0 V)

Fig. 16: Connector wiring TXX / VXX

4.5 Frequently ordered accessories – Additional options available in our [Accessories Guide](#) 551 444

Position magnets

<p>Ring magnet OD33 Part no. 201 542-2</p>	<p>Ring magnet OD25.4 Part no. 400 533</p>	<p>Ring magnet OD17.4 Part no. 401 032</p>	<p>U-magnet OD33 Part no. 251 416-2</p>
<p>Material: PA ferrite GF20 Weight: Approx. 14 g Surface pressure: Max. 40 N/mm² Fastening torque for M4 screws: 1 Nm Operating temperature: -40...+105 °C (-40...+221 °F)</p>	<p>Material: PA ferrite Weight: Approx. 10 g Surface pressure: Max. 40 N/mm² Operating temperature: -40...+105 °C (-40...+221 °F)</p>	<p>Material: PA neobind Weight: Approx. 5 g Surface pressure: Max. 20 N/mm² Operating temperature: -40...+105 °C (-40...+221 °F)</p>	<p>Material: PA ferrite GF20 Weight: Approx. 11 g Surface pressure: Max. 40 N/mm² Fastening torque for M4 screws: 1 Nm Operating temperature: -40...+105 °C (-40...+221 °F)</p>

Position magnet

Magnet spacer

Optional installation hardware

<p>U-magnet OD63.5 Part no. 201 553</p>	<p>Magnet spacer Part no. 400 633</p>	<p>O-ring for flange M18x1.5-6g Part no. 401 133</p>	<p>O-ring for flange 3/4"-16 UNF-3A Part no. 560 315</p>
<p>Material: PA 66-GF30, Magnets compound-filled Weight: Approx. 26 g Surface pressure: 20 N/mm² Fastening torque for M4 screws: 1 Nm Operating temperature: -40...+75 °C (-40...+167 °F)</p>	<p>Material: Aluminum Weight: Approx. 5 g Surface pressure: 20 N/mm² Fastening torque for M4 screws: 1 Nm</p>	<p>Material: Fluoroelastomer 75 ± 5 durometer Operating temperature: -40...+204 °C (-40...+400 °F)</p>	<p>Material: Fluoroelastomer 75 ± 5 durometer Operating temperature: -40...+204 °C (-40...+400 °F)</p>

Manuals, Software & 3D Models available at:
www.mtssensors.com

Controlling design dimensions are in millimeters and measurements in () are in inches

Optional installation hardware

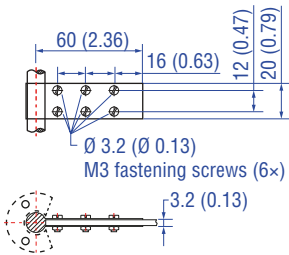

Fixing clip
Part no. 561 481

Application: Used to secure sensor rods (Ø 10 mm (Ø 0.39 in.)) when using an U-magnet
Material: Brass, non-magnetic

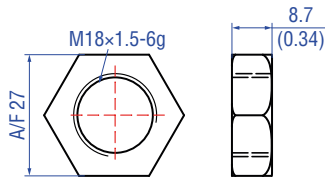

Hex jam nut M18x1.5-6g
Part no. 500 018

Material: Steel, zinc, plated

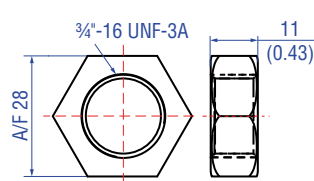

Hex jam nut 3/4"-16 UNF-3A
Part no. 500 015

Material: Zinc plated with nylon insert

Cables

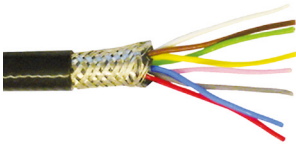

Teflon® cable
Part no. 530 112

Name of cable in order code: **T**
Material: Teflon® jacket; black
Features: Twisted pair shielded
Cable Ø: 7.6 mm (0.3 in.)
Dimensions: 4 × 2 × 0.25 mm²
Bending radius: 8 – 10 × Ø
(fixed installation)
Operating temperature:
-100...+180 °C (-148...+356 °F)



Silicone cable
Part no. 530 113

Name of cable in order code: **V**
Material: Silicone jacket; red
Features: Twisted pair, shielded
Cable Ø: 7.2 mm (0.3 in.)
Dimensions: 3 × 2 × 0.25 mm²
Bending radius: 5 × Ø
(fixed installation)
Operating temperature:
-50...+180 °C (-58...+356 °F)

Manuals, Software & 3D Models available at:
www.mtssensors.com

Controlling design dimensions are in millimeters and measurements in () are in inches

5. Operation

5.1 Getting started

The sensor is factory-set to its order sizes and adjusted, i.e. the required output signal corresponds exactly to the selected stroke length.

NOTICE

Observe during commissioning

1. Before switching on for the first time, check the connection of the sensor carefully.
2. Position the magnet in the measuring range of the sensor during first commissioning and after replacement of the magnet.
3. Ensure that the sensor control system cannot be displaced in an uncontrolled way when switching on.
4. Ensure that the sensor is ready and in operation mode after switching on.

5.2 Programming and configuration

The functional diagram of the sensor with Start/Stop interface is shown in Fig. 17. The start pulse of the controller is acknowledged by the sensor with a stop pulse; the position measurement starts. At the end of the measurement the sensor generates a second stop pulse. The time between the start pulse and the second stop pulse is the travel time.

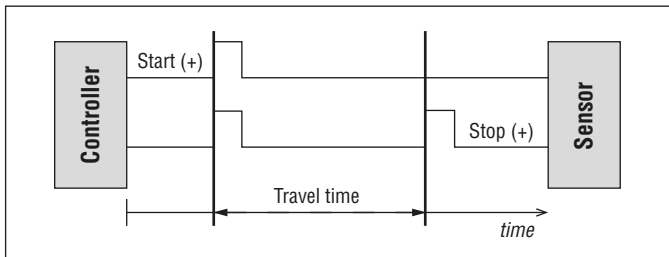

Fig. 17: Functional diagram of sensor with Start/Stop interface

Set the start pulse width and the cycle time according to the stroke length on the controller:

- Start impuls width: 1...2.5 μ s
- Minimal cycle time:
 - 50...1000 mm (2 ... 40 in.) stroke length: 500 μ s
 - 1001...2000 mm (40... 79 in.) stroke length: 900 μ s
 - 2001...3000 mm (79...118 in.) stroke length: 1250 μ s

If the position magnet is out of the stroke length, the sensor does not send a reply signal. This behavior can be evaluated and used for monitoring by the controller.

NOTICE

If the stroke length is exceeded only insignificantly, the sensor generates a reply signal.

Parameter upload

The parameter upload function allows transfer of sensor parameters to the controller. It is easy to measure and store the sensor parameters given below using the same physical interface, without additional connections, via the communication mode to the controller.

Technical data:

Interface: RS-422

Data format: Serial, 4800 baud, 8-bit data

The diagram of the data transfer for parameter upload of the sensor with Start/Stop interface is shown in Fig. 18. The start pulse width has to be $> 10 \mu$ s to start the parameter upload function. A start pulse width $> 2.5 \mu$ s and $< 10 \mu$ s is not permitted. The data is sent to the controller with the low bit first (one start bit "0", one stop bit "1", no parity).

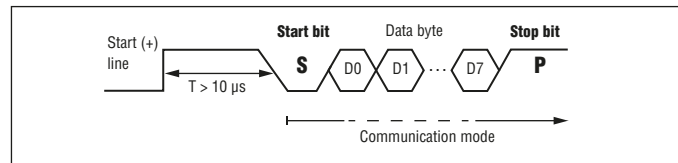

Fig. 18: Diagram of data transfer for parameter upload

The following parameters are transferred via parameter upload function:

1. Gradient

The gradient specifies the travelling speed of the measuring pulse. Gradient and travel time between start pulse and stop pulse are used to determine the position of the position magnet.
Position = gradient \times travel time

The speed of the measuring pulse is approx. 2780 m/s (9.14 μ s/inch.). The exact value is determined during final component checking and specified as a gradient on the sensor label.

2. Offset

The offset indicates the value of the position magnet's position at span start. It is used as a reference value to detect when the stroke length is left and to adapt the position values.
Position = gradient \times travel time – offset

NOTICE

Check gradient after replacing the sensor to avoid errors in position measurement.

3. Stroke length

Indicates the useful measurement displacement of the sensor.

4. Serial number

Every sensor is provided with a unique serial number, which is printed on the sensor label and stored in the sensor.

5. Manufacturer identification

Due to the manufacturer identification, the controller can take manufacturer specific particularities into account.

6. Status

Provides information on the sensor status.

7. Minimum cycle time

The minimum cycle time specifies the time, which has to be between two consecutive start pulses of position measurement. The start pulse for each measurement is generated by the controller.

Data communication

As shown in Fig. 17 communication between controller and sensor is performed via the already provided connections. So the start lines are used for sending from the controller to the sensor, while the stop lines are used for receiving. For data exchange using the parameter upload function the start line is set to level High. The start pulse width has to be > 10 µs to ensure that the sensor switches over safely to the communication mode. Subsequently, the required command can be transmitted to the sensor.

NOTICE

Setting the start line to Low level is considered as a start bit of data transfer and treated accordingly by the sensor. Note that a bit combination which does not correspond to the controller command set is treated as a data fault and re-activates the Start/Stop operation (measuring mode). The occurrence of a data fault can be detected subsequently by a status request.

Read command	Code hex.	Transmitted bytes hex.	Note
Gradient	0x55	4	in cm/s
Offset	0x57	4	in µm
Stroke length	0x59	4	in mm
Serial number	0x5D	4	
Manufacturer recognition MTS Sensors	0x61	4	0
Status	0x5F	4	
Minimum cycle time	0x73	4	in µs
General commands			
Stop communication	0x3D	—	

Fig. 19: Command set for parameter upload function

Telegram formats

Read commands:

Data is transmitted from the sensor to the controller. For this purpose, the controller sends a request command and receives the required data, after the sensor has processed the command. Only after data transmission to the controller, the sensor is ready to receive and process further commands. The communication telegram looks like this:

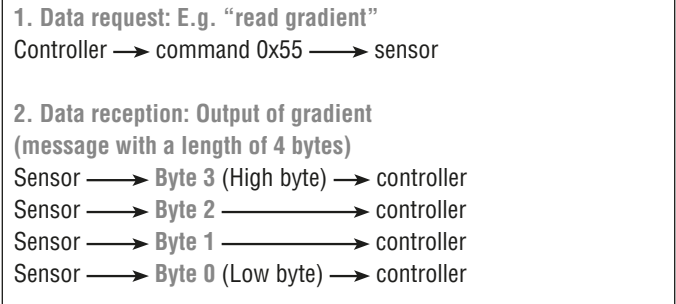

Fig. 20: Communication telegram

NOTICE

The High byte is sent first!

The pause time between bytes is approximately 6 ms.

Status:

The status command is an exception, since the command can be used to retrieve current sensor status information. After requesting the status, the controller can receive the following message:

1. Everything o.k.
Sensor → 0x00 00 00 00 → controller
The sensor did not detect an error.

2. Unknown command
Sensor → 0x00 00 00 AA → controller
An unknown command which is not mentioned in Fig. 19 was received by the sensor. This can be due to trouble on the data line or malfunction of the controller. In this case, the sensor sets the status to 0xAA, leaves the communication mode and starts operating in Start/Stop mode for position determination and position output. After restarting the communication mode, the status byte which is reset to 0x00 can be retrieved. Thus the controller realizes that cancellation is due to trouble.

3. Defective data set in EEPROM
Sensor → 0x00 00 00 FF → controller
When checking the EEPROM data set during start-up, divergence of the calculated checksum from the stored checksum was found. Consequently, there is a risk to use faulty data. If this should be the case, the status is set to 0xFF and the sensor must be re-adjusted. Therefore it is recommended to start a status request after switching on the supply voltage.

Fig. 21: Status command

Terminate communication

Changing from the communication mode to the Start/Stop mode is performed by the command “terminating the communication”:

Sensor → **0x3D** → controller

This command terminates the communication. The operation is continued with the operation in Start/Stop mode for position determination and position output.

6. Maintenance and troubleshooting

6.1 Error conditions, troubleshooting

Error condition	Status
Unknown command	Sensor sets the status to 0xAA

6.2 Maintenance

The required inspections need to be performed by qualified personnel according to IEC 60079-17 / TRBS 1203. These inspections should include at least a visual inspection of the housing, associated electrical equipment entrance points, retention hardware and equipment grounding. Inside the Ex-atmosphere the equipment has to be cleaned regularly. The user determines the intervals for checking according to the environmental conditions present at the place of operation. After maintenance and repair all protective devices removed for this purpose must be refitted.

In case of equipment faults, remove the equipment. The inner parts cannot be maintained by the customer. In this case send the equipment to the manufacturer for inspection.

NOTICE

It is not allowed to open the sensor.

Type of inspection	Visual inspection every 3 months	Close inspection every 6 months
Visual inspection of the sensor for intactness, removal of dust deposits	●	
Check of entire system	User's responsibility	

Fig. 22: Schedule of inspection

Maintenance: Defines a combination of any actions carried out to retain an item in, or restore it to, conditions in which it is able to meet the requirements of the relevant specification and perform its required functions.

Inspection: Defines an activity with the purpose to check a product carefully, aiming at a reliable statement on the condition of the product. The inspection is carried out without dismantling, or, if necessary, with partial dismantling, and supplemented by other measures, e.g. measurements.

Visual inspection: Optical inspection of product aims at the recognition of visible defects like missing bolts without using auxiliary equipment and tools.

Close inspection: Defines an inspection which encompasses those aspects covered by a visual inspection and, in addition, identifies those defects, such as loose bolts, which will be apparent only by the use of access equipment, for example steps, where necessary, and tools.

6.3 Repair

Repairs on the sensor may be performed only by MTS Sensors or an explicitly authorized body.

6.4 List of spare parts

No spare parts are available for this sensor.

6.5 Transport and storage

The conditions of transport and storage of the sensor match the operating conditions mentioned in this document.

7. Removal from service / dismantling

The product contains electronic components and must be disposed of in accordance with the local regulations.

8. Technical data of Temposonics® ET

Output	
Start/Stop	RS-422 differential signal Serial parameter upload available for: Stroke length, offset, gradient, status, serial number and manufacturer number
Measured value	Position
Measurement parameters	
Resolution	Controller dependent
Cycle time	Controller and stroke length dependent Recommendation: Stroke length 50...1000 mm (2... 40 in.): 500 µs Stroke length 1001...2000 mm (40... 79 in.): 900 µs Stroke length 2001...3000 mm (79...118 in.): 1250 µs
Linearity ⁴	≤ ±0.02 % F.S. (minimum ±60 µm)
Repeatability	≤ ±0.005 % F.S. (minimum ±20 µm) typical
Operating conditions	
Operating temperature	-40...+105 °C (-40...+221 °F)
Humidity	90 % relative humidity, no condensation
Ingress protection	Version A and E with Teflon® cable (part no. 530 112): IP66 Version A, E and N with silicone cable (part no. 530 113): IP68 (2 bar (29 psi) @ 30 min)
Shock test	100 g (single shock) / IEC standard 60068-2-27
Vibration test	15 g / 10...2000 Hz IEC 60068-2-6 (resonance frequencies excluded)
EMC test	Electromagnetic emission according to EN 61000-6-3 Electromagnetic immunity according to EN 61000-6-2 The sensor meets the requirements of the EU directives and is marked with CE
Operating pressure	Up to 350 bar (5076 psi)
Magnet movement velocity ⁵	Any
Design / Material	
Sensor electronics housing	Stainless steel 1.4305 (AISI 303); option: Stainless steel 1.4404 (AISI 316L)
Flange	Stainless steel 1.4305 (AISI 303); option: Stainless steel 1.4404 (AISI 316L)
Sensor rod	Stainless steel 1.4306 (AISI 304L); option: Stainless steel 1.4404 (AISI 316L)
Stroke length	50...3000 mm (2...118 in.)
Mechanical mounting	
Mounting position	Any
Mounting instruction	Please consult chapter "4.2 Styles and installation of Temposonics® ET" on page 8
Electrical connection	
Connection type	Cable outlet
Operating voltage	+24 VDC (-15 / +20 %)
Ripple	≤ 0.28 V _{PP}
Current consumption	Maximum 50 mA
Dielectric strength	700 VDC (DC ground to machine ground)
Polarity protection	Up to -30 VDC
Overvoltage protection	Up to ≤ 32 VDC

4/ With position magnet # 251 416-2

5/ If there is contact between the moving magnet including the magnet holder and the sensor rod, make sure that the maximal speed of the moving magnet is ≤ 1 m/s (ATEX requirement due to ESD [Electro Static Discharge])

Certification
⊕ II 3G Ex nC IIC T4 Gc
⊕ II 3D Ex tc IIIC T130 °C Dc IP66 / IP68
Class I/II/III Div 2 T4 ABCDFG
Class I Zone 2 T4 IIC
Zone 22 AEx tc T4 IIIC Dc
-40 °C ≤ Ta ≤ 105 °C, Type: 4X

Fig. 23: Certification of Temposonics® ET (version A and E)

9. Appendix

Safety Declaration

Dear Customer,

If you return one or several sensors for checking or repair, we need you to sign a safety declaration. The purpose of this declaration is to ensure that the returned items do not contain residues of harmful substances and / or that people handling these items will not be in danger.

MTS Sensors order number: _____ Sensor type(s): _____

Serial number(s): _____ Sensor length(s): _____

The sensor has been in contact with the following materials:

Do not specify chemical formulas.
Please include safety data sheets of the substances, if applicable.

In the event of suspected penetration of substances into the sensor, consult MTS Sensors to determine measures to be taken before shipment.

Short description of malfunction:

Corporate information

Company: _____

Address: _____

Contact partner

Name: _____

Phone: _____

E-mail: _____

We hereby certify that the measuring equipment has been cleaned and neutralized.
Equipment handling is safe. Personnel exposure to health risks during transport and repair is excluded.

Stamp

GERMANY
MTS Sensor Technologie GmbH & Co. KG
Auf dem Schüffel 9
58513 Lüdenscheid, Germany
Tel. +49-23 51-95 87 0
Fax. +49-23 51-5 64 91
info.de@mtssensors.com
www.mtssensors.com

Signature

USA
MTS Systems Corporation Sensors Division
3001 Sheldon Drive
Cary, N.C. 27513, USA
Tel. +1 919 677-0100
Fax +1 919 677-0200
info.us@mtssensors.com
www.mtssensors.com

Date

JAPAN
MTS Sensors Technology Corp.
737 Aihara-machi,
Machida-shi,
Tokyo 194-0211, Japan
Tel. +81 42 775-3838
Fax +81 42 775-5512
info.jp@mtssensors.com
www.mtssensors.com

10. Declaration of conformity

EU Declaration of Conformity

EC15.010D

EU-Konformitätserklärung

Déclaration UE de Conformité

MTS Systems Corporation - Sensors Division, 3001 Sheldon Drive, 27513 Cary, NC, USA
MTS Sensor Technologie GmbH & Co. KG, Auf dem Schueffel 9, 58513 Luedenscheid, Germany

declares as manufacturer in sole responsibility that the position sensor type
erklärt als Hersteller in alleiniger Verantwortung, dass der Positionssensor Typ
déclare en qualité de fabricant sous sa seule responsabilité que les capteurs position de type

Temposonics® ET-x-xxxxx-xxx-1-A-R3
ET-x-xxxxx-xxx-1-E-R3

comply with the regulations of the following European Directives:
den Vorschriften folgender Europäischen Richtlinien entsprechen:
sont conformes aux prescriptions des directives européennes suivantes :

2014/34/EU Equipment and protective systems for use in potentially explosive atmospheres
Geräte und Schutzsysteme zur Verwendung in explosionsgefährdeten Bereichen
Appareils et systèmes de protection à être utilisés en atmosphères explosibles

2014/30/EU Electromagnetic Compatibility
Elektromagnetische Verträglichkeit
Compatibilité électromagnétique

Applied harmonized standards:
Angewandte harmonisierte Normen:
Normes harmonisées appliquées :

EN 60079-0:2012+A11:2013, EN 60079-15:2010, EN 60079-31:2014
EN 61000-6-2:2005+AC :2005, EN 61000-6-3:2007+A1:2011

EC type examination certificate: **CML 16ATEX 4352X Issue 1**
EG-Baumusterprüfbescheinigung:
Certificat de l'examen CE:

issued by / ausgestellt durch / exposé par: **Certification Management Limited (2503)**
Ellesmere Port CH65 4LZ, United Kingdom

Notified body for quality assurance control: **Certification Management Limited**
Benannte Stelle für Qualitätsüberwachung: **Ellesmere Port CH65 4LZ, United Kingdom**
Organisme notifié pour l'assurance qualité:

Ident number / Kennnummer / No. d'identification: **2503**

Marking / Kennzeichnung / Marquage: **II 3G Ex nC IIC T4 Gc**
II 3D Ex tc IIIC T130°C Dc IP66/IP68
Start/Stop : -40°C ≤ T_{amb} ≤ +105°C

Luedenscheid, 2017-05-31

MTS Sensor Technologie GmbH & Co. KG

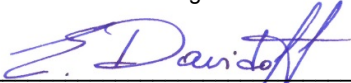

Dr.-Ing. Eugen Davidoff
Approvals Manager
EX Authorized Representative

EU Declaration of Conformity
EU-Konformitätserklärung
Déclaration UE de Conformité

EC15.010D

MTS Sensor Technologie GmbH & Co. KG, Auf dem Schueffel 9, 58513 Luedenscheid, Germany

declares as manufacturer in sole responsibility that the position sensor type
erklärt als Hersteller in alleiniger Verantwortung, dass der Positionssensor Typ
déclare en qualité de fabricant sous sa seule responsabilité que les capteurs position de type

Temposonics ET-x-xxxxx-Txx-1-N-R3
ET-x-xxxxx-Vxx-1-N-R3

comply with the regulations of the following European Directives:
den Vorschriften folgender Europäischen Richtlinien entsprechen:
sont conformes aux prescriptions des directives européennes suivantes :

2014/30/EU Electromagnetic Compatibility
Elektromagnetische Verträglichkeit
Compatibilité électromagnétique

Applied harmonized standards:
Angewandte harmonisierte Normen:
Normes harmonisées appliquées :

EN 61000-6-2:2005, EN 61000-6-3:2007+A1:2011

Luedenscheid, 2017-06-30

MTS Sensor Technologie GmbH & Co. KG, Auf dem Schueffel 9, 58513 Luedenscheid, Germany



Thomas Muckenhaupt
Head of Quality Management



QPS Evaluation Services Inc
Testing, Certification and Field Evaluation Body
Accredited in Canada, the USA, and Internationally

File
LR1346

CERTIFICATE OF COMPLIANCE
(ISO TYPE 3 CERTIFICATION SYSTEM)

Issued to	MTS Sensor Technologie GmbH & Co KG
Address	Auf Dem Schüffel 9, Lüdenscheid, Germany, D-58513
Project Number	LR1346-3
Product	Linear Position Sensors
Model Number	Tempsonics ® E-Series ET (see annex below for full model information)
Ratings/Markings	see annex below for full marking information
Applicable Standards	CSA C22.2 No. 60079-0:2015, CSA C22.2 No. 60079-15:2016, CSA C22.2 No 60079-31:2015, CSA C22.2 No 61010-1:2012, CSA C22.2 94.2:2015 ANSI/ISA 12.12.01 (2015), ANSI/UL 61010-1 (2012), ANSI/UL 50E 2nd Edition, ANSI/UL 60079-0 (2013), ANSI/UL 60079-31 (2015), ANSI/UL 2225 (2013)
Factory/Manufacturing Location	Same as above

Statement of Compliance: The product(s) identified in this Certificate and described in the Report covered under the above referenced project number have been investigated and found to be in compliance with the relevant requirements of the above referenced standard(s). As such, they are eligible to bear the QPS Certification Mark shown below, in accordance with the provisions of QPS's Service Agreement.



Issued By: Dave Adams P.Eng.

Signature: 

Date: March 28, 2017



QPS Evaluation Services Inc
Testing, Certification and Field Evaluation Body
Accredited in Canada, the USA, and Internationally

File
LR1346

Annex:

Product: Linear Position Sensors Tempsonics ® E-Series ET
 Models: SSI Output, Analog & Digital Start/Stop

Model (output)	Canada	US
Analog	Ex nC IIC T4 Gc Ex tc IIIC T130°C Dc IP66/68 -40°C ≤Ta≤85°C Type 4X	Class I/II/III Div 2 T4 ABCDFG Class I Zone 2 T4 IIC Zone 22 AEx tc T4 IIIC Dc -40°C ≤Ta≤85°C, Type 4X
Digital Start/Stop	Ex nC IIC T4 Gc Ex tc IIIC T130°C Dc IP66/68 -40°C ≤Ta≤105°C Type 4X	Class I/II/III Div 2 T4 ABCDFG Class I Zone 2 T4 IIC Zone 22 AEx tc T4 IIIC Dc -40°C ≤Ta≤105°C, Type 4X
SSI Output	Ex nC IIC T4 Gc Ex tc IIIC T130°C Dc IP66/68 -40°C ≤Ta≤90°C Type 4X	Class I/II/III Div 2 T4 ABCDFG Class I Zone 2 T4 IIC Zone 22 AEx tc T4 IIIC Dc -40°C ≤Ta≤90°C, Type 4X

*Models are differentiated by output signal type

Each model has its own designated ambient range and dust temperature limitation (see table).

The sensors are supplied with a permanently connected cable with a rated voltage of 24 (-15%, +20%) VDC and a maximum current of 105 mA.

The equipment is intended for permanent field installation.

Model nomenclature below:



IECEX Certificate of Conformity

INTERNATIONAL ELECTROTECHNICAL COMMISSION IEC Certification Scheme for Explosive Atmospheres

for rules and details of the IECEx Scheme visit www.iecex.com

Certificate No.: IECEx CML 16.0125X Issue No: 1 Certificate history:
Issue No. 1 (2017-03-09)
Status: **Current** Page 1 of 4 Issue No. 0 (2017-02-23)
Date of Issue: **2017-03-09**
Applicant: **MTS Sensor Technologie GmbH**
Auf Dem Schüffel 9
Ludenscheid
D-58513
Germany
Equipment: **Linear Position Sensor Temposonics E-Series ET**
Optional accessory:
Type of Protection: **Sealed Device "nC", Protection by enclosure "tc"**
Marking:
Ex nC IIC T4 Gc
Ex tc III C T130°C Dc
Refer to Annex for further marking detail.

Approved for issue on behalf of the IECEx
Certification Body:

A Snowdon

Position:

Certification Officer

Signature:
(for printed version)

Date:

March 9, 2017

1. This certificate and schedule may only be reproduced in full.
2. This certificate is not transferable and remains the property of the issuing body.
3. The Status and authenticity of this certificate may be verified by visiting the [Official IECEx Website](http://www.iecex.com).

Certificate issued by:

Certification Management Limited
Unit 1, Newport Business Park
New Port Road
Ellesmere Port, CH65 4LZ
United Kingdom





Sensor with Ex approval

Document Part Number:
551677 Revision D (EN) 07/2017

LOCATIONS

USA
MTS Systems Corporation
Sensors Division
3001 Sheldon Drive
Cary, N.C. 27513, USA
Tel. +1 919 677-0100
Fax +1 919 677-0200
info.us@mtssensors.com
www.mtssensors.com

JAPAN
MTS Sensors Technology Corp.
737 Aihara-machi,
Machida-shi,
Tokyo 194-0211, Japan
Tel. +81 42 775-3838
Fax +81 42 775-5512
info.jp@mtssensors.com
www.mtssensors.com

FRANCE
MTS Systems SAS
Zone EUROPARC Bâtiment EXA 16
16/18, rue Eugène Dupuis
94046 Creteil, France
Tel. +33 1 58 4390-28
Fax +33 1 58 4390-03
info.fr@mtssensors.com
www.mtssensors.com

GERMANY
MTS Sensor Technologie
GmbH & Co. KG
Auf dem Schüffel 9
58513 Lüdenscheid, Germany
Tel. +49 2351 9587-0
Fax +49 2351 56491
info.de@mtssensors.com
www.mtssensors.com

CHINA
MTS Sensors
Room 504, Huajing Commercial Center,
No. 188, North Qinzhou Road
200233 Shanghai, China
Tel. +86 21 6485 5800
Fax +86 21 6495 6329
info.cn@mtssensors.com
www.mtssensors.com

ITALY
MTS Systems Srl
Sensor Division
Via Camillo Golgi, 5/7
25064 Gussago (BS), Italy
Tel. +39 030 988 3819
Fax +39 030 982 3359
info.it@mtssensors.com
www.mtssensors.com

LEGAL NOTICES

MTS, Temposonics and Level Plus are registered trademarks of MTS Systems Corporation in the United States; MTS SENSORS and the MTS SENSORS logo are trademarks of MTS Systems Corporation within the United States. These trademarks may be protected in other countries. All other trademarks are the property of their respective owners. Copyright © 2017 MTS Systems Corporation. No license of any intellectual property rights is granted. MTS reserves the right to change the information within this document, change product designs, or withdraw products from availability for purchase without notice. Typographic and graphics errors or omissions are unintentional and subject to correction. Visit www.mtssensors.com for the latest product information.

