

Temposonics®

Absolute, Non-Contact Position Sensors

OPERATION MANUAL
R-Series Analog



Table of contents

1. Introduction	2
1.1 Purpose and use of this manual	2
1.2 Used symbols and warnings	2
2. Safety instructions	2
2.1 Intended use.....	2
2.2 Installation, commissioning and operation.....	3
2.3 Safety instructions for use in explosion-hazardous areas.....	3
2.4 Warranty.....	3
2.5 Return	3
3. Identification	4
3.1 Order structure	4
3.2 Nameplate (example)	6
3.3 Approvals.....	6
3.4 Scope of delivery	6
4. Product description and commissioning	6
4.1 Functionality and system design	6
4.2 Styles and installation	7
4.3 Electrical connection	11
4.4 Accessories.....	12
5. Operation	13
5.1 Getting started	13
5.2 Programming and configuration	14
5.3 Sample configuration	14
6. Maintenance and troubleshooting	20
6.1 Error conditions, troubleshooting	20
6.2 Maintenance.....	20
6.3 Repair	20
6.3 List of spare parts	20
7. Removal from service/dismantling	20
7.1 Disposal	20
8. Technical data	20
8.1 Input.....	20
8.2 Output	20
8.3 Performance.....	20
8.4 Operating conditions	21
8.5 Design and material.....	21
8.6 Installation.....	21
8.7 Power supply.....	21
8.8 Electrical connection	21
9. Annex	22
Safety Declaration	22
10. Notes	23

1/ The term “qualified technical personnel” characterizes persons who:
- are familiar with the safety concepts of automation technology applicable to the particular project,
- are competent in the field of EMC,

1. Introduction

1.1 Purpose and use of this manual

Before starting the operation of Temposonics® sensors read this documentation thoroughly and follow the safety information.

The content of this technical documentation and of its various annexes is intended to provide information on mounting, installation and commissioning by qualified automation personnel ¹ or instructed service technicians who are familiar with the project planning and dealing with Temposonics® sensors.

1.2 Used symbols and warnings

Warnings are intended for your personal safety and for avoidance of damage to the described product or connected devices. In this documentation, safety information and warnings to avoid dangers that might affect the life and health of operating or service personnel or cause material damage are highlighted by the preceding pictogram, which is defined below.

Symbol	Meaning
NOTICE	This symbol is used to point to situations that may lead to material damage, but not to personal injury.

2. Safety instructions

2.1 Intended use

This product may be used only for the applications provided under item 1 and item 2 and only in conjunction with the third-party devices and components recommended or approved by MTS Sensors. As a prerequisite of proper and safe operation, the product requires correct transport, storage, mounting and commissioning and must be operated with utmost care.

1. The sensor systems of all Temposonics® series are intended exclusively for measurement tasks encountered in industrial, commercial and laboratory applications. The sensors are considered as system accessories and must be connected to suitable evaluation electronics, e.g. a PLC, IPC, indicator or other electronic control unit.
2. The position sensors must be used only in technically safe condition. To maintain this condition and to ensure safe operation, installation, connection and service work may be performed only by qualified technical personnel.

1/ - have received adequate training for commissioning and service operations
- are familiar with the operation of the device and know the information required for correct operation provided in the product documentation.

2.2 Installation, commissioning and operation

If danger of injury to persons or of damage to operating equipment is caused by sensor failure or malfunction, additional safety measures such as plausibility checks, limit switches, EMERGENCY STOP systems, protective devices etc. are required. In the event of trouble, shut down the sensor and protect it against accidental operation.

Installation, operation

To maintain the sensor operability, it is mandatory to follow the instructions given below.

1. Protect the sensor against mechanical damage during installation and operation.
2. Do not open or dismantle the sensor.
3. Connect the sensor very carefully and pay attention to the polarity of connections, power supply as well as to the shape and duration of control pulses.
4. Use only approved power supplies.
5. It is indispensable to ensure that the specified permissible limit values of the sensor for supply voltage, environmental conditions, etc. are met.
6. Check the function of the sensor regularly and provide documentation of the checks.
7. Before system switch-on, ensure that nobody's safety is jeopardized by starting machines.

2.3 Safety instructions for use in explosion-hazardous areas

The sensor is not suitable for operation in explosion-hazardous areas.

2.4 Warranty ²

MTS grants a warranty period for the Temposonics® position sensors and supplied accessories relating to material defects and faults that occur despite correct use in accordance with the intended application ². The MTS obligation is limited to repair or replacement of any defective part of the unit. No warranty can be taken for defects that are due to improper use or above average stress of the product, as well as for wear parts. Under no circumstances will MTS accept liability in the event of offense against the warranty rules, no matter if these have been assured or expected, even in case of fault or negligence of the company.

MTS explicitly excludes any further warranties. Neither the company's representatives, agents, dealers nor employees are authorized to increase or change the scope of warranty.

2.5 Return

For diagnostic purposes, the sensor can be returned to MTS Sensor Technologie GmbH. Any shipment cost will be borne by the sender ². For a corresponding form, see chapter 9 (Annex).

^{2/} see also applicable MTS Sales and supply conditions, e.g. under www.mtssensor.com

3.2 Nameplate (example)

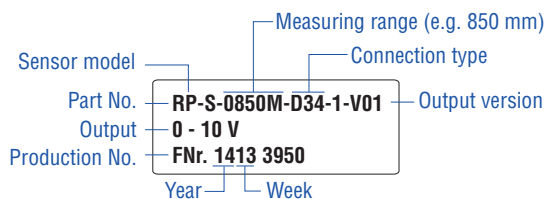

3.3 Approvals

The sensor conforms to the EU directives and is provided with CE and GOST marking.

3.4 Scope of delivery

Profile

Sensor, position magnet, 2 mounting clamps up to 1250 mm
+ 1 clamp for each 500 mm.

Rod:

Sensor and O-ring

4. Product description and commissioning

4.1 Functionality and system design

Product designation

– Position sensor Temposonics® R-series

Construction series

- Temposonics® RP (profile-style housing)
- Temposonics® RH (rod-style housing)
- Stroke length RP: 25...5000 mm; RH: 25...7600 mm
- Output signal: Analog

Application

The Temposonics® sensor is used for measurement and conversion of the position variable in the field of automated system and mechanical engineering.

Principle of operation and system construction

For position measurement, the absolute, linear Temposonics® position sensors make use of the properties offered by the specially designed magnetostrictive waveguide. Inside the sensor a torsional strain pulse is induced in the waveguide by momentary interaction of two magnetic fields. The interaction between these two magnetic fields produces a strain pulse, which is detected by the electronics at the head of the sensor. One field is produced by a moving position magnet, which travels along the sensor rod with the waveguide inside. The other field is generated by a current pulse applied to the waveguide. The position of the moving magnet is determined precisely by measuring the time elapsed between the application of the current pulse and the arrival of the strain pulse at the sensor head. The result is a reliable position measurement with high accuracy and repeatability.

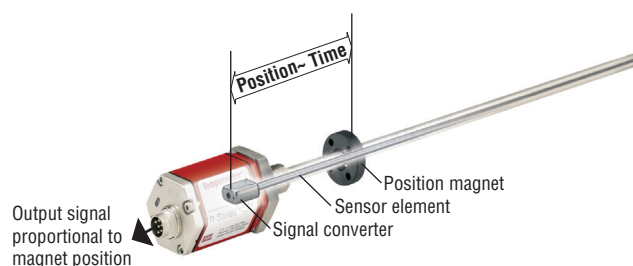

Fig. 1: Principle of operation:
Magnetostrictive runtime measurement = position information

Modular mechanical and electronic construction

- The sensor housing (profile- or rod-style) protects the sensor element.
- The sensor electronics housing, a rugged aluminum construction, contains the complete electronic interface with active signal conditioning. Double shielding ensures high safety of operation and optimum EMC (Electromagnetic compatibility).
- The external position magnet is a permanent magnet. Mounted on the mobile machine part, it travels along the sensor rod or profile- and triggers the measurement through the housing wall. The sensor is connected via a plug.
- The sensor can be connected directly to a control system. Its electronics generates a strictly position-proportional signal output between zero and end position.

4.2 Styles and installation

Temposonics® RP profile style

Purpose: e.g. mounting on machines

The profile-style sensor can be operated with various position magnets:

- Profile-guided magnet carriages are connected to the mobile machine part via a ball coupling to compensate alignment errors.

- A free position magnet on the mobile machine part travels along the measuring rod at a defined distance. Alignment errors can be compensated via the air gap.

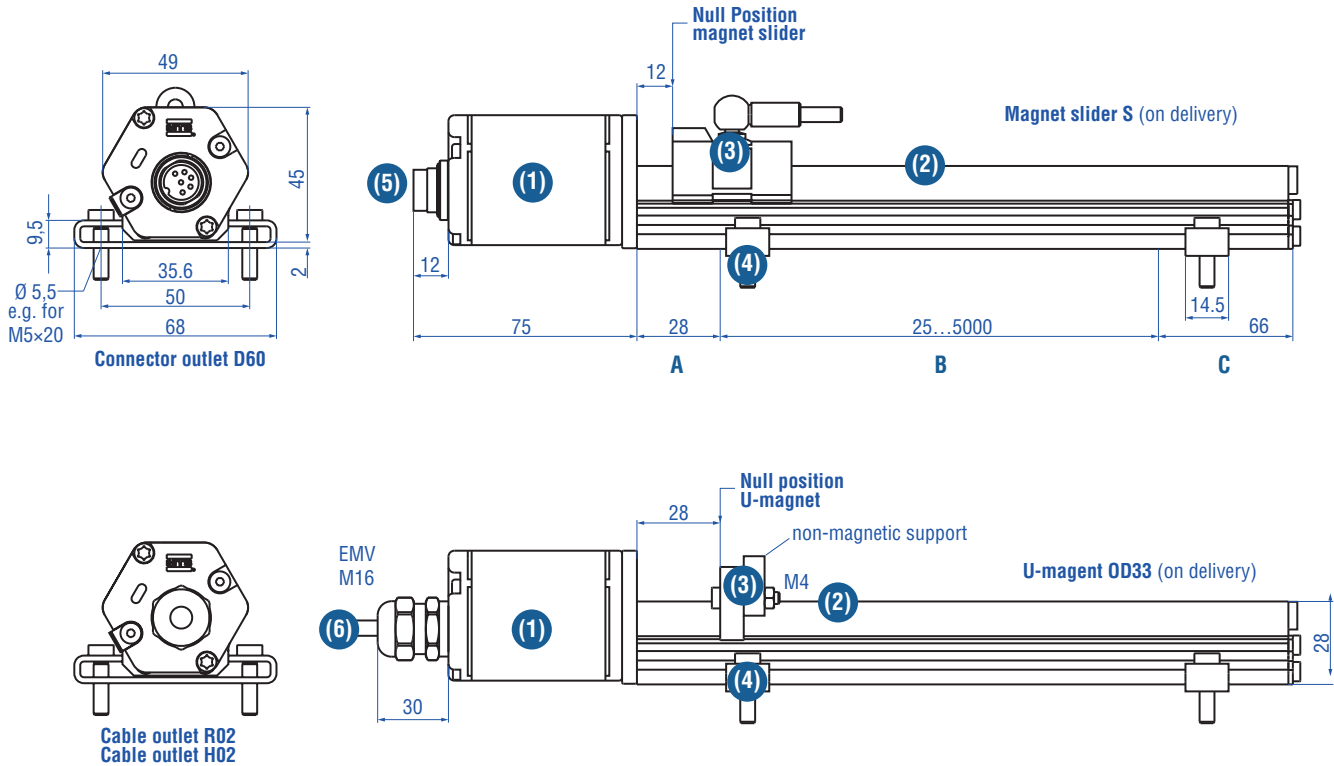

Fig. 2: Temposonics® RP³

- (1) Sensor electronics housing⁴
- (2) Profile with inner sensor element
- (3) Position magnet
- (4) Mounting clamp, moveable
- (5) Electrical connection
- (6) EMC cable gland

- A Mounting zone
- B Stroke length
- C Inactive zone

³/ All dimensions in mm.

Temposonics® RH rod style

Purpose: e.g. installation in hydraulic cylinders

The pressure-resistant stainless steel rod is installed in the fluid power system in the cylinder and externally, if space conditions are limited. Position measurement is contactless via ring or U-magnets.

Advantage...

For servicing the complete basic sensor can be easily replaced *without opening* the fluid circuit.

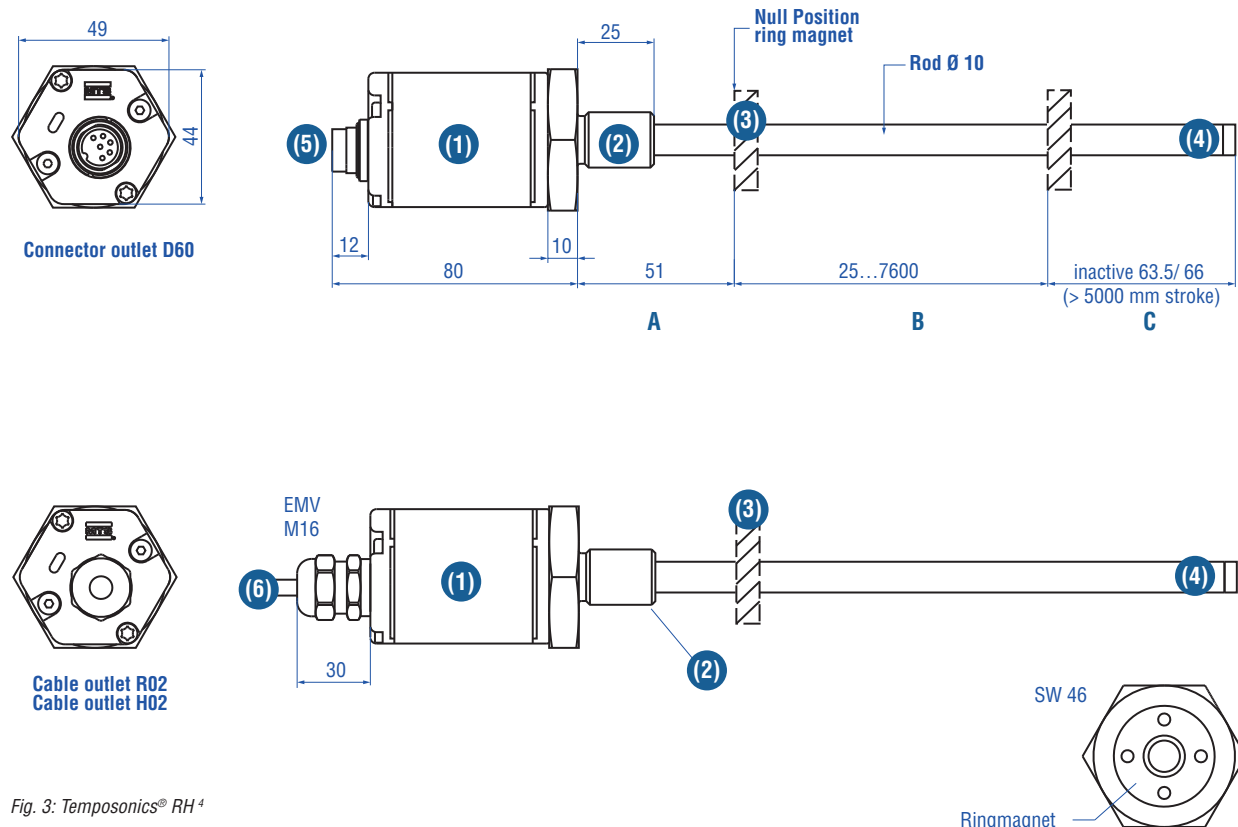

Fig. 3: Temposonics® RH⁴

- (1) Sensor electronics housing⁶
- (2) Bolted flange M18 × 1.5 or ¾"-16UNF-3A
- (3) Position magnet
- (4) Sensor rod with inner sensor element, Ø 10 mm
- (5) Electrical connection
- (6) EMC cable gland

- A Mounting zone
- B Stroke length
- C Inactive zone

4/ All dimensions in mm

Active measuring range

The technical data of each sensor is checked as well as documented and the active stroke length (useful electrical stroke) with its start and end position is adjusted during final inspection and testing (see dimension drawing).

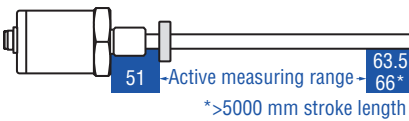
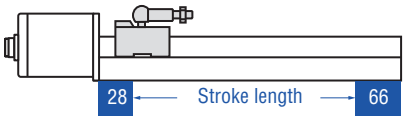

Fig. 4: Active sensor stroke⁵

NOTICE

On all sensors, the areas left and right of the active stroke length are provided for mounting and damping of the measuring signal. They should not be used for measurement, but the active stroke length can be exceeded without problem.

Mechanical zero

To ensure that the entire measuring range can be used electrically, the position magnet must be mounted mechanically as follows:

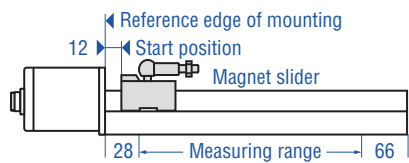

Fig. 5⁵:
Temposonics® profile with magnet slider “S” and “V”

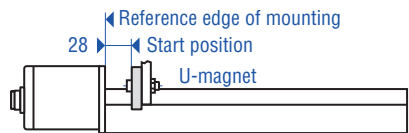

Fig. 6⁵:
Temposonics® profile with U-magnet OD33

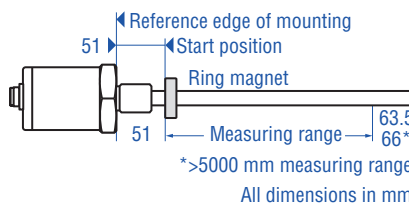

Fig. 7⁵:
Temposonics® rod with ring magnet

Installation of a profile-style sensor

The position sensor can be installed in any position. Normally, the sensor is firmly installed and the position magnet is fastened to the mobile machine part. Thus it can travel along the measuring rod contactlessly.

The sensor is fitted on a flat machine surface using the mounting clamps (see fig. 8). A length-dependent number of these clamps are delivered with the sensor and must be distributed over the profile at regular distances.

For fastening, we recommend using M5 × 20 screws to DIN 6912 that should be tightened with a maximum torque of 5 Nm.

Alternative: If only limited space is available, the profile sensor can be mounted also via the T-rail in the profile bottom using an M5 T-slot nut or a sliding block (see fig. 9).

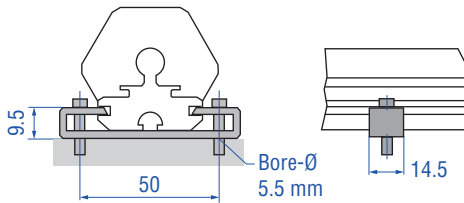

Fig. 8⁷: Mounting clamps with cylinder screw M5 × 20, fastening torque < 5 Nm

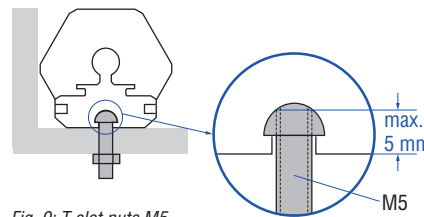

Fig. 9: T-slot nuts M5

NOTICE

Don't mount the sensors in the area of strong magnetic or electric noise fields. Take care to mount the sensor in an axially parallel position to avoid damaging the carriage, magnet and measuring rod.

The sensor is isolated from the machine ground. For this reason, earthing via the flat-pin connector on the sensor electronics housing is indispensable (see fig. 10).

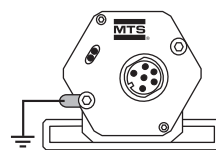

Fig. 10: Grounding profile sensor

Mounting the U-magnet

The U-magnet is removable and can be used for profile- and rod-style sensors. Using a non-magnetizable entrainment device is mandatory. The magnet must not rub against the measuring rod. Alignment errors are compensated via the air gap.

- Max. surface pressure: 40 N/mm²
- Max. tightening torque for M4 screws: 1 Nm; use washer, if necessary

- 1 U-magnet
- 2 Non-magnetic entrainment device

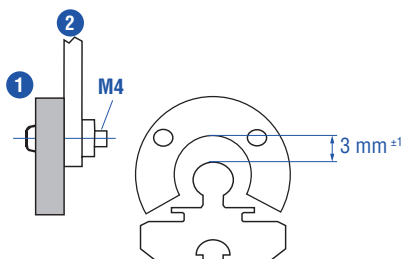

Fig. 11: Entrainment device for U-magnet

NOTICE

A maximum permissible air gap of 3 mm must not be exceeded.

Large measuring lengths from 1 meter

Horizontally installed sensors should be supported mechanically at the rod end. Longer rods require evenly distributed mechanical support over the entire length. In this case U-magnets (see fig. 12) are used for measurement.

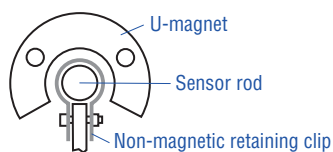

Fig. 12: Example of sensor support

Installation of a rod-style sensor

The rod-style version has been developed for direct stroke measurement in a fluid cylinder.

- Mounted on the bottom of the piston, the ring magnet travels over the rod contactlessly and marks the position exactly through the rod wall - independent of the hydraulic fluid.
- Inside the pressure-resistant sensor housing immersing into the open piston rod, the basic sensor is mounted by means of only two screws. It is the only part that needs replacing if servicing is required, i.e. the hydraulic circuit remains closed.

NOTICE

After re-installing, securing the basic sensor screws, e.g. using Loctite 243, is mandatory.

Rod with inner sensor element immersed in the cylinder

Pressure-resistant sensor housing

In the event of servicing, the rod with the flange remains in the cylinder.

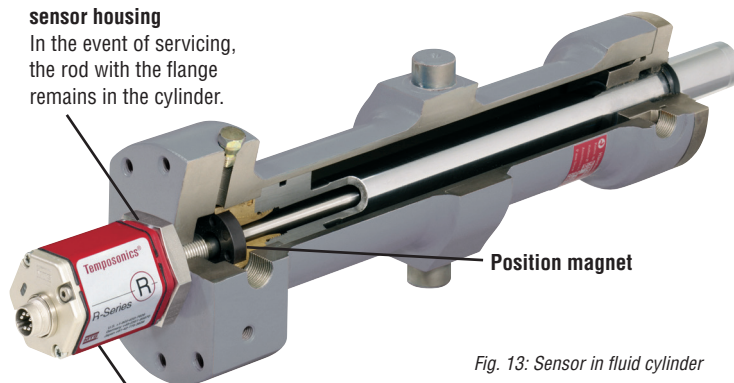

Fig. 13: Sensor in fluid cylinder

Basic sensor

The electronics head with sensing element can be replaced via two M4 screws with a 2.5 mm hexagonal recess, max. tightening torque 1.3 Nm

Mount the sensor via flange thread or a hex nut. If possible, non-magnetizable material should be used for mounting support (dimensions as shown). With horizontal mounting, longer sensors (from 1 meter) recommend provided with mechanical support. Observe dimensions (see fig. 14 / fig. 15).

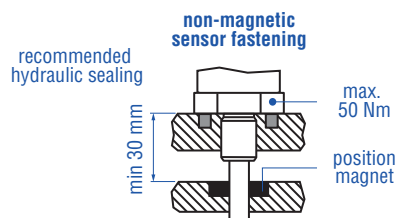

Fig. 14: Installation with non-magnetizable material

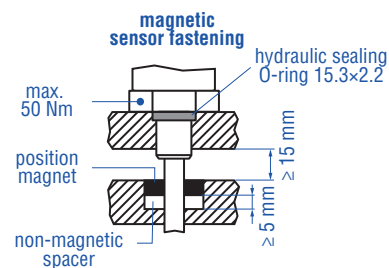

Fig. 15: Installation with magnetizable material

NOTICE

For mounting by means of screws, use only a hexagonal flange width across flats 46 mm below the sensor electronics housing (electronics) and avoid exceeding the maximum tightening torque of 50 Nm.

Mounting the ring magnet

Install the magnet using non-magnetizable material for entrainment device, screws, spacers etc.

- Max. permissible surface pressure: 40 N/mm²
- Max. tightening torque for M4 screws: 1 Nm; use washers, if necessary

Hydraulics sealing

We recommend sealing the flange contact surface using an O-ring (e.g. 22.4 × 2.65) in a cylinder bottom groove. However, sealing via a 15.3 × 2.2 O-ring in the undercut is also possible (Fig. 13.) In this case, a screw hole to ISO 6149-1 must be provided.

- The flange contact surface must be seated completely on the cylinder mounting surface.
- The cylinder manufacturer determines the pressure-resistant gasket (copper gasket, O-ring, etc.).
- The position magnet should not rub against the rod.
- The plunger borehole (min. Ø 13 mm) depends on the pressure and piston speed.
- The peak pressure should not be exceeded.
- Protect the sensor rod from wear using suitable constructive measures.

4.3 Electrical connections

Place of installation and cabling have decisive influence on the sensor EMC. Hence correct installation of this active electronic system and the EMC of the entire system must be ensured by using suitable metal connectors, shielded cables and grounding. Overvoltages or faulty connections can damage its electronics despite protection against wrong polarity.

NOTICE

Do not make connections under voltage!

Instruction for connection

- Low-resistance, pairwisely twisted, screened cables should be used and the shield should be connected to earth externally in the evaluation electronics
- Control and signal leads should be kept separate from power cables and sufficiently far away from motor cables, frequency inverters, valve lines, relays, etc.
- Use only connectors with metal housing and connect the screening to connector housing.
- The connecting surface at both screening ends should be as large as possible.
- Keep all non-screened leads as short as possible
- The earth connection should be as short as possible with a large cross section. Avoid ground loops.
- With potential differences between machine and electronics earth connections, no compensating currents are allowed to flow across the cable screening.
Our Recommendation:
install potential compensating lead with large cross section, or use cables with separate double screening, and connect only one end of screen.
- Use only stabilized power supplies in compliance with the specified connecting values.

NOTICE

The profile sensor must be grounded on the flat plug on the electronics housing.

Connection types

The sensor must be connected directly with the control system according to wiring diagram:

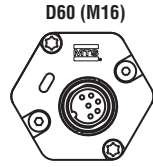

1. Connector outlet D60
6 pin connector M16

R02/H02 (cable outlet)

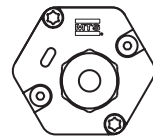

2. Cable outlet Rxx
xx m PVC cable 3 × 2 × 0.14 mm²
3. Cable outlet Hxx
xx m PUR cable 3 × 2 × 0.25 mm²

Fig. 16: View: Connection side sensor / mating connectors



Male insert sensor plug rear of cable connector

Fig. 17: Wiring

Pin	Cable	Signal
1	GY	Position magnet 1 0...10/10...0/-10...+10/+10...-10 VDC / 4(0)...20/20...4(0) mA ⁹
2	PK	DC Ground
3	YE	Position magnet 2 or speed magnet 1 0...10/10...0/-10...+10/+10...-10 VDC / 4...20/20...4 mA ⁹
4	GN	Signal Ground
5	BN	+24 VDC (-15 / +20 %)
6	WH	DC Ground

NOTICE

MIND THE HAZARD OF SHORT CIRCUITS!

When using only output 1, insulation of the yellow and green cores (output 2) is indispensable. Recommendation:
Providing terminals for output 2 in the control cabinet, because the leads are eventually required in case of sensor programming.

4.4 Accessories

Position magnets for sensor profile ⁶

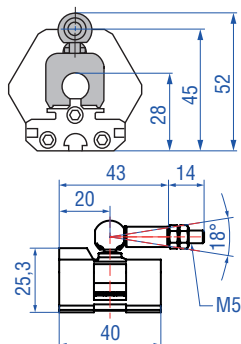

Magnet slider S
Part no. 252 182

Material: GRP, magnet hard ferrite
Joint CuZn39Pb3 nickel-plated
Weight: ca. 30 g
Operating temperature: -40...+75 °C

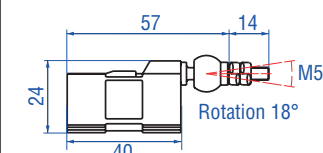
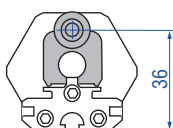

Magnet slider V
Part no. 252 184

Material: GRP, magnet hard ferrite
Joint CuZn39Pb3 nickel-plated
Weight ca. 30 g
Operating temperature: -40...+75 °C

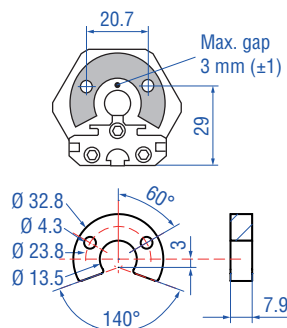

U-magnet OD33
Part no. 251 416-2

Material: PA-Ferrit-GF20
Weight: ca. 11 g
Operating temperature: -40...+100 °C
Surface pressure max. 40 N/mm²
Fastening torque for M4 screws
max. 1 Nm

Position magnets for sensor rod ⁶

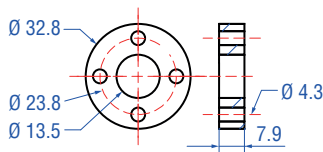

Ring magnet OD33
Part no. 201 542-2

Material: Composite PA-Ferrite-GF20
Weight: ca. 14 g
Operating temperature: -40...+100 °C
Surface pressure max. 40 N/mm²
Fastening torque for M4 screws
max. 1 Nm

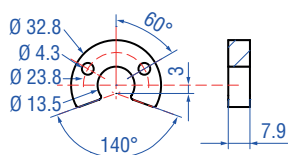

U-magnet OD33
Part no. 251 416-2

Material: PA-Ferrit-GF20
Weight: ca. 11 g
Operating temperature: -40...+100 °C
Surface pressure max. 40 N/mm²
Fastening torque for M4 screws
max. 1 Nm

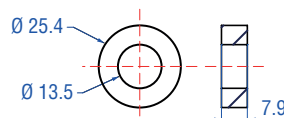

Ring magnet OD25,4
Part no. 400 533

Material: Composite PA-Ferrite
Weight: ca. 10 g
Operating temperature: -40...+100 °C
Surface pressure max. 40 N/mm²

Female connector ⁶ (When connecting the mating connector please notice the mounting instructions of the manufacturer of the packaging.)

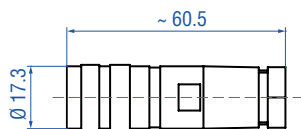

Female, straight, 6 pin
Part no: 370 423

Housing: zinc nickel plated
Termination: solder
Contact insert: silver plated
Cable clamp: PG9
Cable Ø: 6...8 mm

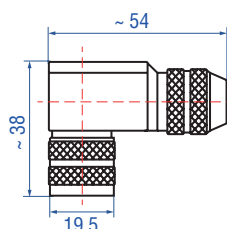

Female, angled, 6 pin
Part no.: 370 460

Housing: zinc nickel plated
Termination: solder
Contact insert: silver plated
Cable Ø: 6...8 mm

⁶/ All dimensions in mm

MTS Servicetools



Analog hand programmer – R-Series
(for sensors with 1 magnet)
Part no. 253 124

Easy teach-in-setups of stroke length and direction on desired zero/span positions. For the first output.



Programming kit – R-Series
(for sensors with 1 or 2 magnets)
Part no. 253 134-1

Kit includes: interface converter box, power supply, setup software, cabling and CD-ROM.



Analog cabinet programmer – R-Series
Part no. 253 408

Features snap-in mounting on standard 35 mm DIN rail. This programmer can be permanently mounted in a control cabinet and includes a program/run switch. For the first output.

5. Operation

5.1 Getting started

The sensor is factory-set to its order sizes and adjusted, i.e. the required output signal corresponds exactly to the selected measuring length.

Example: Output 4...20 mA = 0...100 % stroke length

Diagnostic display

(Red/green) LEDs in the sensor electronics lid provide information on the current sensor condition.

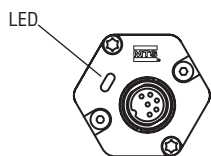

Fig. 18: LED-Display

Green	Red	Description
ON	OFF	Normal function
ON	ON	Magnet not detected, wrong magnet quantity
ON	FLASHING	Magnet out of setup range
FLASHING	ON	Programming mode

NOTICE

1. Before initial switch-on, check carefully if the sensor has been connected correctly.
2. Ensure that the sensor control system cannot be displaced in an uncontrolled way when switching on.
3. If the sensor is operational and in operating mode after switching on, the diagnostics LED is lit permanently (green).
4. Check the preset span start and end values of the measuring range (see section 4.2) and correct them via the customer's control system, if necessary.

NOTICE

Setting the sensors in the field

The sensors can be re-adjusted if necessary on service tools described below.

5.2 Programming and configuration

MTS Sensors Servicetools

Temposonics® sensors can be easily adapted – without opening sensor housing – to changing measuring tasks via connecting wires. Therefore the user can use several MTS Sensors Servicetools which can be chosen from the accessories.

Handheld-Programmer R-Analog,

Part no. 253 124

Handheld-programmer R-Analog, directly connected to the sensor is provided for setup of measuring range by moving the magnet on desired Null/Span positions (minimum distance between setpoints: 25 mm) and pushing the corresponding 0 % respectively 100 % buttons on programmer.

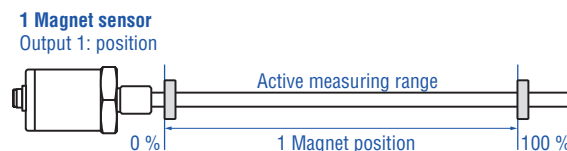

Fig. 19: Measuring with 1 magnet

Programmer connection

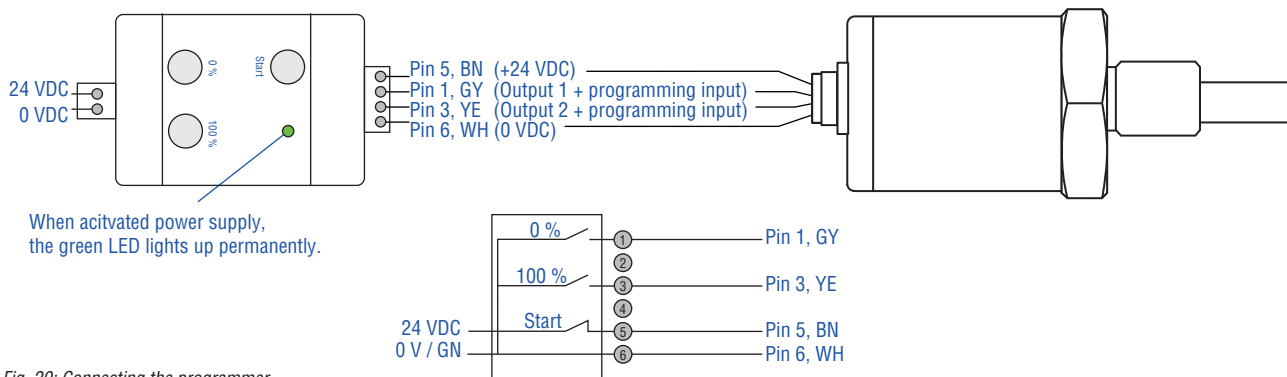

Fig. 20: Connecting the programmer

Adjustment

Activate the programming mode:

- Press start button and 100 % button
- Release start button and also 100 % button after 1 sec.
- The green sensor LED flashes (programming mode reached)

Set start point (0 % output): 0 VDC (–10 VDC), 4 mA (0 mA)

- Set the magnet on start position
- Press the 0 % button shortly

Set end point (100 % output) = 10 VDC / 20 mA:

- Set the magnet on end position
- Press 100 % button shortly

Back to normal function:

- Press start button shortly
- LED programming mode stops flashing
- Sliding switch on RUN

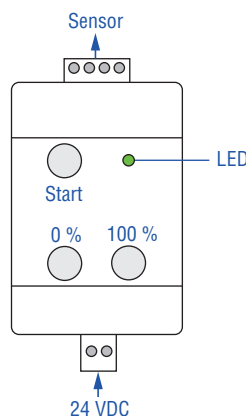

Fig. 21: Adjustment of measuring range

NOTICE

In normal function the green LED on sensor is glowing permanently.

**Cabinet-Programmer R-Analog,
Part no. 253 408**

Cabinet-Programmer R-Analog, connected between sensor and control unit is provided for setup of measuring range by moving the magnet on desired Null/Span positions (minimum distance between setpoints: 25 mm) and pushing the corresponding 0 % respectively 100 % buttons on programmer.

1 Magnet sensor
Output 1: position

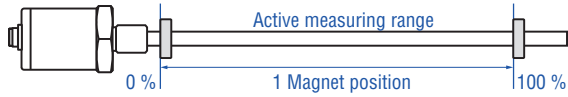

Fig. 22: Measuring with 1 magnet

Mounting

The programmer electronics housing is designed for snap-in mounting on standard 35 mm rails (EN 607 15/50022). It is suitable for connection between sensor and controller in a cabinet. The programming mode can be activated without any servicetool at any time.

Wiring

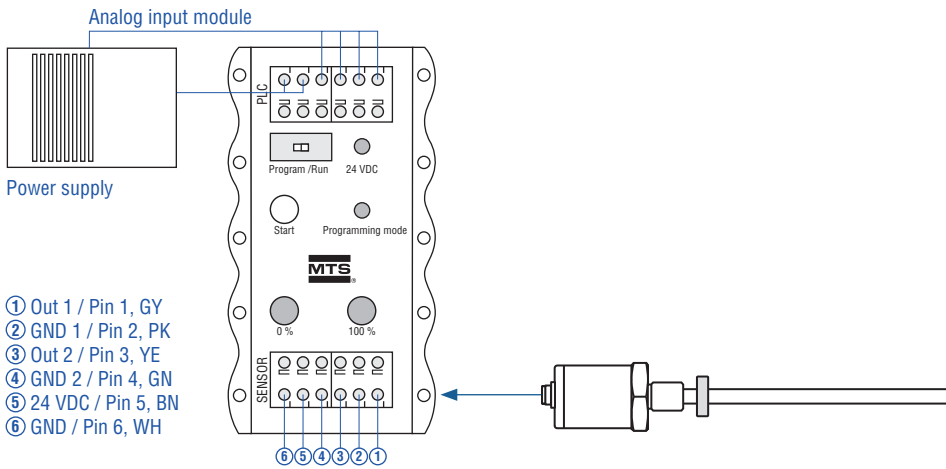

Fig. 24: Connecting sensor with cabinet programmer

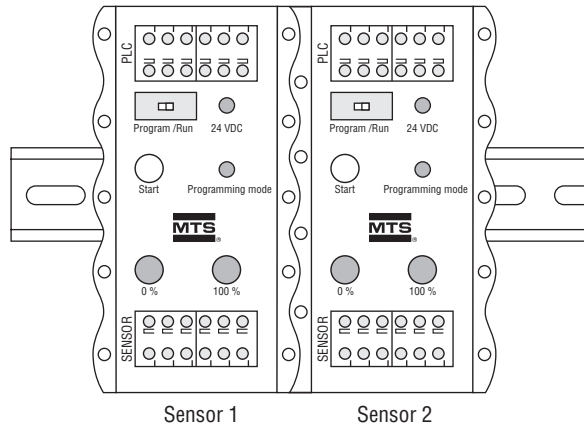
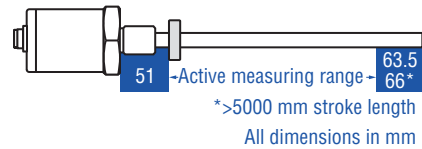

Fig. 23: Dimensions: 10 × 55 × 31 mm;
Material: Aluminum, side caps PA 6.6 FR;
Connection: Spring terminals, max. 1.5 mm²;
Protection: IP20



Adjustment

Normal function:

- Sliding switch on RUN (now all sensor leads are connected with control unit)
- Green LED 24 VDC shows normal function

Activate Programming mode:

- Sliding switch on PROGRAMM
- Press start button and 100 % button
- Release start button and also after 1 second the 100 % button
- Green programming mode LED flashes (programming mode reached)

Set start point (0 % output) = 0 VDC / -10 VDC / 4 mA / 0 mA:

- Set the magnet to start position
- press 0 % button shortly

Set end point (100 % output) = 10 VDC / 20 mA:

- Set the magnet to end position
- Press 100 % button shortly

Back to normal function:

- Press start button shortly
- LED programming mode stops flashing
- Sliding switch on RUN

NOTICE

In normal function the green LED on sensor is glowing permanently.

PC programmer R-Analog,

Part no. 253 134-1

PC programmer R-Analog, a hardware converter, can be used for customized sensor settings. Parameters of 1 or 2 magnets sensors can be changed within the active stroke via Windows PC and analog configurator by MTS Sensors.

Depending on the sensor design, tool allows menu-driven change of:

- Start-/end-position magnet 1 and 2 (minimum distance between new setpoints: 25 mm)
- Velocity
- Output assignment to the measured values (positionen 1, 2 or velocity)
- Output signal with errors (e.g. no magnet)

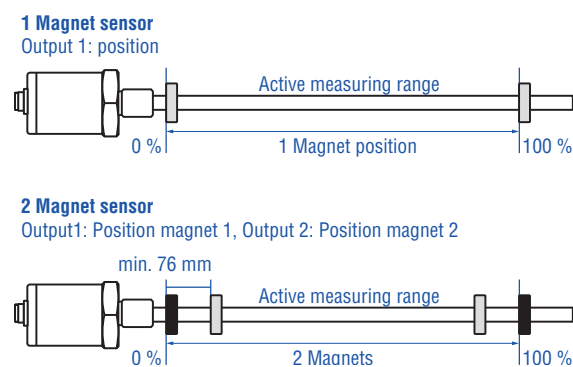

Fig. 25: Active measuring range

Connect programmer

- Connect programmer with the sensor via the corresponding cable.
- Connect the programmer via USB port with the PC.
- Connect the power supply via jack on the side. The external contact of the connector is 0 V (ground).

NOTICE
Do not make connections under voltage!

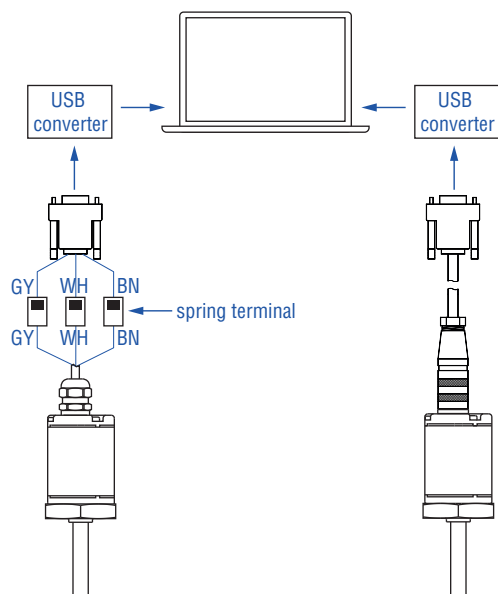

Fig. 26: Programmer connection (left: with spring terminal, right: with cable)

Software installation

Copy AnalogConfigurator.exe from the CD into a directory of your choice on the hard disk and start the program. The program now displays a list of available COMs. Normally, the COM port with the lowest number (e.g. COM1) should be selected.

If a connection fails, it could be a missing driver. In this case, install the USB-Serial-Converter driver from the enclosed CD-ROM.

Program start

After starting the analog configurator, the relevant windows user interface of the connected 1 or 2 sensor with its adjustable parameters will open (fig. 27).

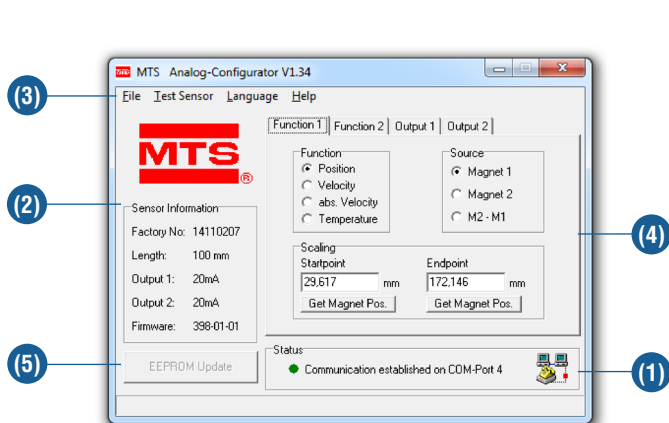

Fig. 27: Example of windows surface

- (1) **Status** indicates that the sensor is connected successfully.
- (2) Frame **Sensor Information** contains the invariable sensor parameters, which are read in automatically when connecting the sensor.
- (3) In the **file** menu, the sensor configuration can be saved on the hard disk, printed out or loaded into the sensor ⁷. Moreover, this menu permits returning to the factory setting.
- (4) The control tabs of mainframe permit allocation of functions to the sensor outputs. Via **Function** the position, speed or a direction dependent absolute speed values are selectable. The measuring range of the functions will be determined in **Scaling**.
- (5) Any changes which were made are shown with dark background. By clicking on **EEPROM update**, the altered parameters are sent and stored permanently in the sensor. Subsequently, the stored values are displayed again with a white background.

Tabs control frame

- (6) Via tabs control **Function 1**, the analog sensor output can be allocated to the position or speed of the magnet. With position measurement, the measuring range with start point and end point is determined here.
- (7) The actual magnet position can be stored via buttons **Get Magnets Pos.** (Note: On sensors with 2 magnets, value storage always relates only to the first magnet).
- (8) Allocation of the relevant analog output signals to sensor functions position or speed measurement is via index card Output 1 (fig. 28).

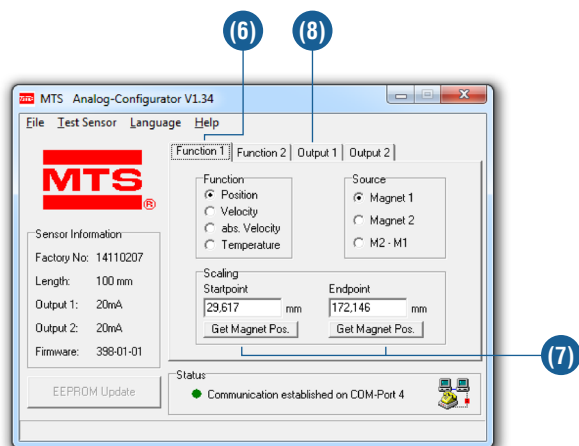

Fig. 28: Example of tab controls

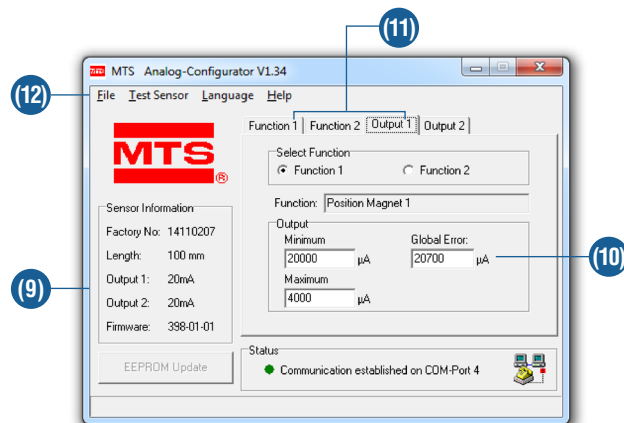

Fig. 29: Example of tab controls

- (9) Thereby, field Output Minimum indicates the current or voltage value which should be output at the starting point of the selected function. The output value pertaining to the end point must be specified in field Output Maximum (fig. 29).
- (10) Unless a position magnet is provided, or if it is in the sensor inactive zone, i.e. out of measuring range, Global Error is output. The error value can be adjusted with $-0.7 \dots 20.7 \text{ mA}$ or $-0.4 \dots 10.4 \text{ V}$
- (11) Index cards **Function 2**, **Output 2** and the functional reference to the 2nd magnet in field Source, are provided only for sensors with two analog outputs.
- (12) Menu Sensor test provides a data display (fig. 30), which show the absolute positions of the position magnets. Compared with the sensor measuring rate, serial data transmission between sensor and PC is relatively slow, i.e. not every actually measured value can be displayed. For this reason, only every 50th measurement value appears in the diagram.

Data display

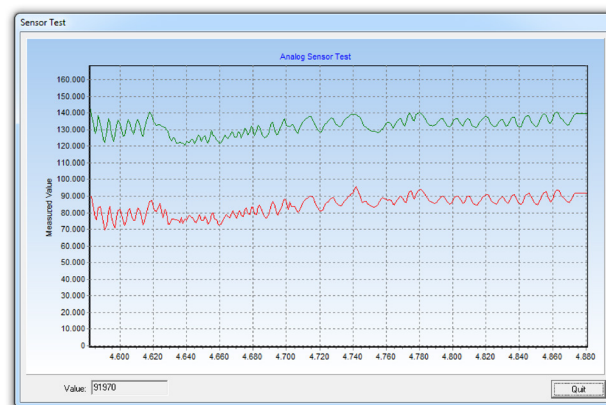

Fig. 30: Diagram Test Sensor of analog sensor with 2 position magnets

⁷/only sensor configurations with the same serial number permitted

**Setting examples for hand-held programming device
or installation programmer**

The sensor measurement range can be positioned with the tools described forward any time. Custom Measurement ranges are also already set and come from the factory stating the position of the set points SP1 and SP2 but on request it.

NOTICE
Regardless of the direction of measurement, the set points SP1 always the electronics housing and SP2 are always positioned on the rod end (Fig. 31).

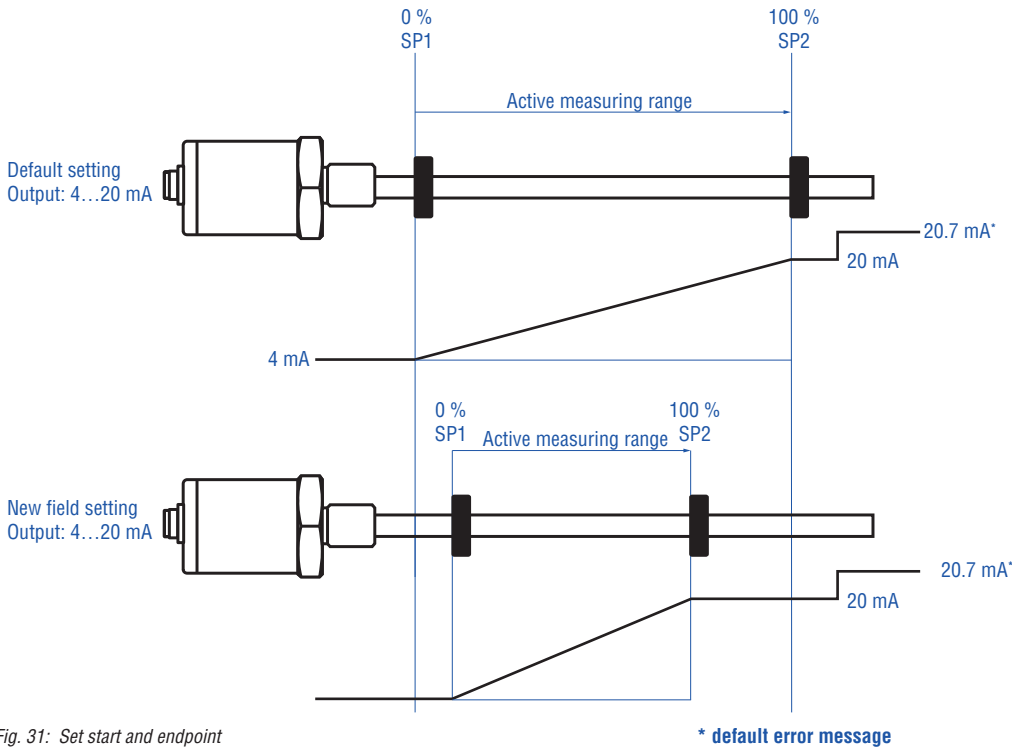

Fig. 31: Set start and endpoint

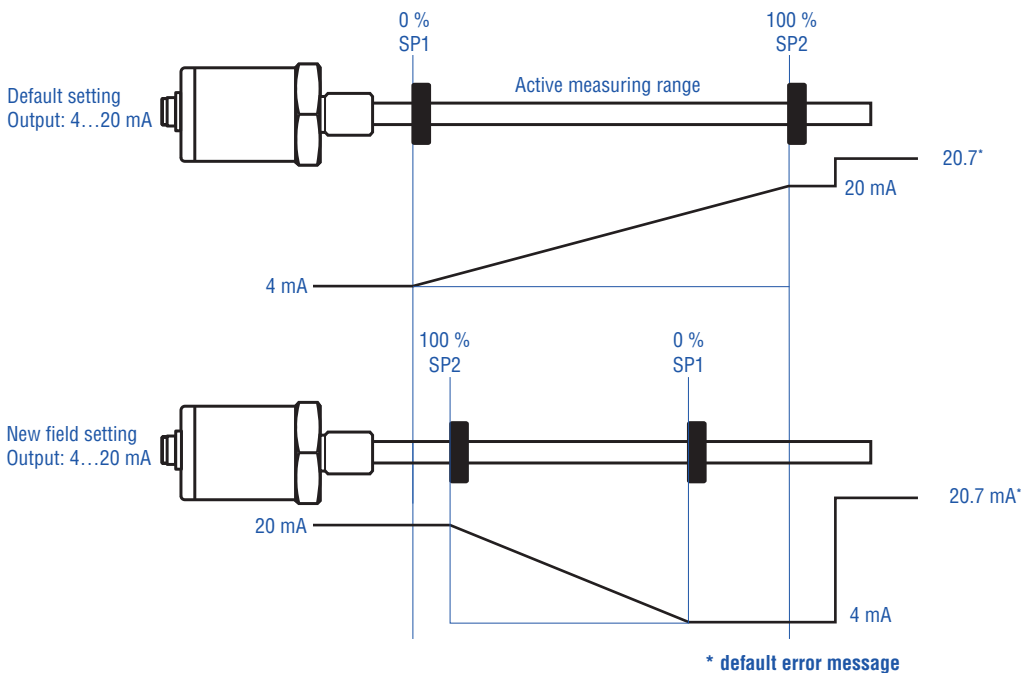

Fig. 32: Start and end point, set the direction

6. Maintenance and troubleshooting

6.1 Error conditions, troubleshooting

See chapter 5 "Operation", fig. 18.

6.2 Maintenance

The sensor is maintenance-free.

6.3 Repair

Repairs on the sensor may be performed only by MTS or an explicitly authorized body.

6.4 List of spare parts

Omitted

7. Removal from service

7.1 Disposal

The product contains electronic components and must be disposed of in accordance with the local regulations.

8. Technical data

8.1 Input

Measured value	Position / velocity / dual magnet position measurements
Stroke length	Profile: 25...5000 mm / rod: 25...7600 mm

8.2 Output

1. Voltage	0...10/10...0/-10...+10/+10...-10 VDC (min. load controller: > 5 kOhm)
2. Current	4(0)...20/20...4(0) mA (min. / max. load: 0/500 Ohm)

8.3 Performance

Position measurement:

- Null/Span adjustment	100 % F.S. (min. range 25 mm)
- Resolution	16 bit; 0,0015 % (minimum 1 µm)
- Linearity	< ±0.01 % F.S. (minimum ±50 µm)
- Repeatability	< ±0.001 % F.S.
- Hysteresis	< 4 µm
- Update times	0.5 ms up to 1200 mm; 1.9 ms up to 2400 mm / 2.0 ms up to 4800 mm; 5.0 ms up to 7600 mm
- Ripple	< 0.01 % F.S.

Velocity measurement:

- Range	Velocity range 1: 0.1...10 m/s; Velocity range 2: 25...90 mm/s
- Deviation	< 0.5 %
- Resolution	0.1 mm/s, Option 0.01 mm/s
- Update time	0.5 ms up to 1200 mm; 1.9 ms up to 2400 mm / 2.0 ms up to 4800 mm; 5.0 ms up to 7600 mm
Temperature coefficient	< 30 ppm/°C

8.4 Operating conditions

Magnet movement velocity	any
Operating temperature	-40...+75 °C
Dew point, humidity	90% rel. humidity, no condensation
Ingress protection	Profile: IP65 / Rod: IP67, IP68 with cable outlet
Shock test	100 g (single hit) IEC-Standard 60068-2-27
Vibration test	15 g / 10...2000 Hz IEC-Standard 60068-2-6
EMC test	Electromagnetic emission acc. to EN 61000-6-4, CISPR 16 Electromagnetic immunity acc. to EN 61000-6-2 EN 61000-4-2/3/4/6, Level 3/4, Kriterium A, CE-qualified

8.5 Design and material

Diagnostic display	LED beside connector
<u>Profile model:</u>	
Sensor electronics housing / Profile	aluminum / aluminum
Position magnet	magnet slider or removable U-magnet
<u>Rod model:</u>	
Sensor electronics housing / Sensor rod	aluminum / stainless steel 1.4301 / AISI 304
Operating pressure	350 bar, 700 bar peak
Position magnet	Ring- or U-magnets

8.6 Installation

Mounting position	any
Profil	Adjustable mounting feet or T-slot nut in bottom groove
Position magnet	Mounting plate and screws from antimagnetical material; U-magnet, removable
Sensor rod	Threaded flange M18 × 1.5 or 3/4" -16 UNF-3A
Position magnet	Mounting plate and screws from antimagnetical material

8.7 Power supply

Operating voltage	24 VDC (-15 / +20 %)
Current consumption	typ. 100 mA
Ripple	≤ 0.28 Vpp

8.8 Electrical connection

Connection type	6 pin connector M16 or cable outlet
Dielectric strength	500 VDC (DC ground to machine ground)
Polarity protection	up to -30 VDC
Overvoltage protection	up to 36 VDC

9. Annex

Safety Declaration

Dear Customer,

If you return one or several for checking or repair, we need you to sign a safety declaration. The purpose of this declaration is to ensure that the returned items do not contain residues of harmful substances and / or that any danger to persons when handling these items is excluded.

MTS order number: _____ Sensor type(s): _____

Serial number(s): _____ Sensor length: _____

The sensor has been in contact with the following materials:

Don't specify chemical formulas.
Please, include safety data sheets of the substances, if applicable.

In the event of suspected penetration of substances into the sensor, consult MTS to determine measures to be taken before shipment, if necessary.

Short description of malfunction:

Corporate information

Company: _____

Address: _____

Contact partner

Name: _____

Phone: _____

E-Mail: _____

We hereby certify that the measuring equipment has been cleaned and neutralized. Equipment handling is safe. Personnel exposure to health risks during transport and repair is excluded.

Stamp

Signature

Date

Document Part Number:
551393 Revision B (EU.EN) 05/2014

LOCATIONS

GERMANY

MTS Sensor Technologie GmbH & Co. KG
Auf dem Schüffel 9
58513 Lüdenscheid, Germany
Tel. +49 2351 9587-0
Fax +49 2351 56491
info.de@mtssensors.com
www.mtssensor.de

USA

MTS Systems Corporation Sensors Division
3001 Sheldon Drive
Cary, N.C. 27513, USA
Tel. +1 919 677-0100
Fax +1 919 677-0200
info.us@mtssensors.com
www.mtssensors.com

JAPAN

MTS Sensors Technology Corp.
737 Aihara-machi,
Machida-shi,
Tokyo 194-0211, Japan
Tel. +81 42 775-3838
Fax +81 42 775-5512
info.jp@mtssensors.com
www.mtssensor.co.jp

FRANCE

MTS Systems SAS
Zone EUROPARC Bâtiment EXA 16
16/18, rue Eugène Dupuis
94046 Creteil, France
Tel. +33 1 58 4390-28
Fax +33 1 58 4390-03
info.fr@mtssensors.com
www.mtssensor.com

ITALY

MTS Systems Srl.Sensor Division
Via Diaz,4
25050 Provaglio d'Iseo (BS), Italy
Tel. +39 030 988 3819
Fax +39 030 982 3359
info.it@mtssensors.com
www.mtssensor.com

CHINA

MTS Sensors
Room 504, Huajing Commercial Center,
No. 188, North Qinzhou Road
200233 Shanghai, China
Tel. +86 21 6485 5800
Fax +86 21 6495 6329
info.cn@mtssensors.com
www.mtssensors.cn

LEGAL NOTICES

MTS and Temposonics® are registered trademarks of MTS Systems Corporation. All other trademarks are the property of their respective owners. Printed in Germany. Copyright © 2014 MTS Sensor Technologie GmbH & Co. KG. Alterations reserved. All rights reserved in all media. No license of any intellectual property rights is granted. The information is subject to change without notice and replaces all data sheets previously supplied. The availability of components on the market is subject to considerable fluctuation and to accelerated technical progress. Therefore we reserve the right to alter certain components of our products depending on their availability. In the event that product approbations or other circumstances related to your application do not allow a change in components, a continuous supply with unaltered components must be agreed by specific contract.

ISO 9001
CERTIFIED

