

# Temposonics®

Absolute, Non-Contact Position Sensors

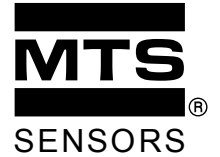

## Instruction Manual

---

**Rod model  
Temposonics-RH**

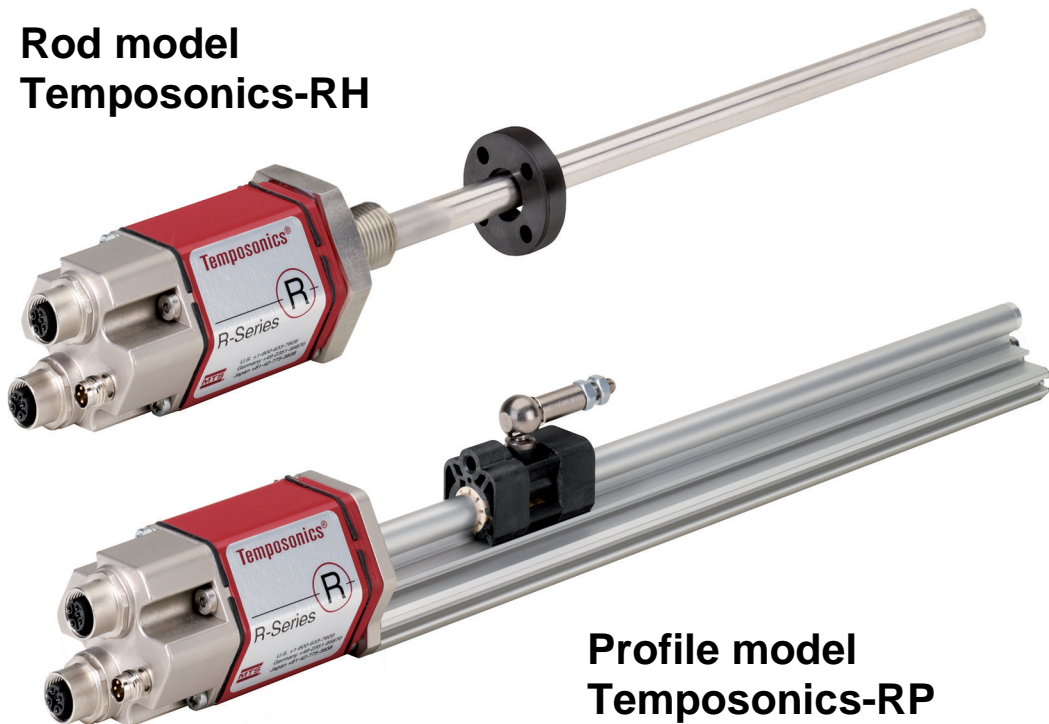

**Profile model  
Temposonics-RP**

---

## Temposonics R-Series

EtherCAT Interface

## Content

1. Safety and operating instructions
2. Product description
3. Installation
  - 3.1 Temposonics-RP, Profile model
  - 3.2 Temposonics-RH, Rod model
  - 3.3 Fluid cylinder integration of rod sensor
  - 3.4 Cylinder handling after sensor installation
4. Wiring
5. Getting started
  - 5.1 At a glance - brief instructions
6. Example of configuration: TwinCAT System Manager (Beckhoff)
  - 6.1 Configuration of Ethernet card
  - 6.2 Starting TwinCAT System Manager
  - 6.3 Add the Ethernet card as an I/O device
  - 6.4 Adding a sensor as a Box
  - 6.5 Setting up and parameterizing the sensor
  - 6.6 Sensor in operation
7. Annex TwinCAT manager
  - 7.1 Description of tool bar buttons
  - 7.2 CAN Indices
8. Sensor specifications

This instruction manual explains the installation, starting up, software and parameterization of Temposonics Position Sensors by qualified personnel\* or trained service technicians who are conversant with Temposonics Sensor projecting and handling.

**Please read this documentation carefully before sensor operation and follow the safety instructions!**

## 1. Safety and operating instructions

### Intended use

TEMPOSONICS Sensors are manufactured in accordance with the established safety standards of electrical engineering and correspond to the state-of-the-art. The sensors meet the European Guideline 89/336/EEC (91/386/EEC, 93/44/EEC) and comply with the EMC standards for electromagnetic emission EN 50081-1 and electromagnetic immunity EN 50082-2.

Risks for the user or a third party can, however, arise during operation and damage can occur to the sensor or other objects. TEMPOSONICS Sensors are intended for measurements (displacement and speed) in industrial, commercial and laboratory applications. They are considered as system components and must be connected to suitable evaluation electronics - for example PLC, IPC, an indicator or to other electronic controls.

The sensors may only be used for the applications listed in the technical description and only in conjunction with units and components recommended or approved by MTS. Prerequisites of correct and safe sensor operation are the correct transport, storage, installation and starting up of the sensors and careful operation.

The sensors may only be used in a completely safe condition. In order to maintain this condition and to ensure safe operation, the installation, connection and service of the sensors may only be carried out by specialized and qualified personnel\*.

### Warnings and safety instructions

Warnings included in the operation instructions are for the protection of person and to avoid damage to the sensors or connected units.

### Installation and operation

If failure or dysfunction of the sensor could cause the risk of injury to persons or damage of production facilities, additional safety measures such as plausibility checks, limit switches, EMERGENCY OFF systems, protective devices etc. must be taken. Should problems arise, the sensor must be taken out of operation and protected against unauthorized operation.

- In order to maintain its operability, the following precautions must be taken:
- Protect the sensors against mechanical stress during installation and operation.
- Do not open or disassemble the sensors.
- Connect the sensors accurately with regard to polarity, supply voltage and form as well as duration of control pulses.
- Use approved power supplies only.
- Observe permissible limits for input voltage, environmental conditions etc. as specified in data sheets.
- Check the position sensor function regularly and document the tests.
- Before switching on the system, make sure that no danger can arise for persons due to starting machinery.

### Repairs

Sensor repairs may only be carried out by MTS or by an organization explicitly authorized by MTS.

### Warranty

In case of material deficiencies and faults which occur despite operation in compliance with the regulations, the warranty assumed by MTS for Temposonics Sensors is 12 months on receipt of the product.

The MTS liability is limited to repair or replacement of any defective part of the instrument. No warranty can be assumed for deficiencies due to improper handling or above average wear of the product, or for wear parts.

MTS cannot be held responsible for consequences or side effects in the case of violation against the warranty conditions\*\*, independent of whether promised or expected, not even in the case of manufacturer error or negligence.

In this respect, MTS explicitly denies any further warranty. Neither MTS representatives, agents and dealers nor their employees are authorized to increase or change the warranty conditions. The warranty conditions are exclusively valid as set out at [www.mtssensor.de](http://www.mtssensor.de).

---

\* Qualified personnel are persons who

- are familiar with the automation safety concepts related to projecting
- are familiar with EMC
- have undergone training for commissioning and servicing
- are familiar with the operation of the system and the product documentation for correct operation.

\*\*The MTS warranty conditions are exclusively valid as set out at [www.mtssensor.de](http://www.mtssensor.de).

## 2. Product description

TEMPOSONICS are linear sensors for position and velocity (option) measurements in a wide range of industrial automation devices. The sensors combine the reliability of non-contact, magnetostrictive technology and the advantage of absolute signal outputs.

Manufacturer: MTS Sensor Technologie, Auf dem Schüffel 9, 58513 Lüdenscheid , Germany  
 Product name: TEMPOSONICS R-Series position sensors, including models  
 • Temposonics-RP (Profile housing)  
 • Temposonics-RH (Rod housing)  
 Output: EtherCAT ( E 101 for 1-5 magnets measurements )  
 EtherCAT ( E 102 für 1-20 magnets measurements )  
 Measuring range: Profile 25..5000 mm, Rod 25...7600 mm  
 Validity: As of models built in 2009

### Type label

The type label on the sensor includes all the information needed when speaking to our Service Technicians or for ordering spare parts. The label is attached to the sensor electronic head. You find:

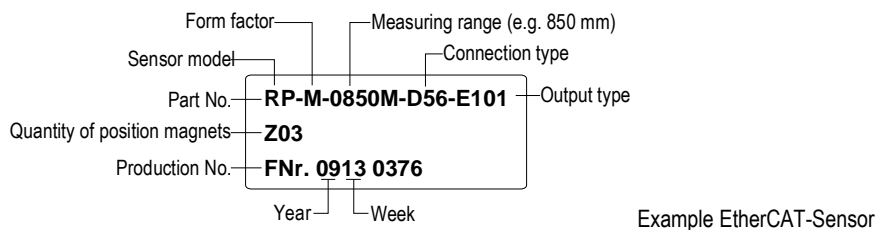

### 2.1 Form factor

The sensors are mechanically and electronically designed in a modular system which is user friendly:

- A profile or rod-shaped sensor housing protects the sensing element which emits the measurement signal.
- The sensor head accommodates the complete modular electronic interface with active signal processing. Double encapsulation ensures high operating safety and optimum EMC protection.
- The external position transmitter - a permanent magnet without intrinsic power supply - moves above the sensor and is mechanically decoupled. The loosening of two screws is all that is necessary to access the sensor head with the evaluation electronics. Servicing and replacements are extremely easy and non-expensive.

### 2.2 Measuring principle

TEMPOSONICS sensors have a non-wearing measurement technique which makes servicing unnecessary. This and their compact form are the sensors' distinguishing features during operation.

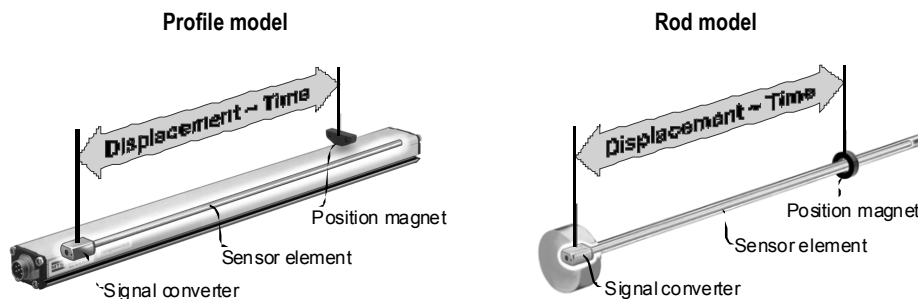

The sensors are based on the magnetostrictive principle - developed by MTS - which combines various magneto-mechanical effects using the speed of an ultrasonic pulse in the sensor element for highly accurate physical measurements. These measurements are transformed directly in the sensor into customary standard outputs. The sensors precisely detect the position of an external permanent magnet through the housing wall to measure displacements and velocities.

This non-contact sensing eliminates wear, noise and erroneous signal problems and guarantees excellent durability without any recalibration. Its absolute nature provides instant recognition of machine position after power loss recovery without driving a reference point.

### 2.3 EtherCAT sensor interface

EtherCAT (Ethernet Control Automation Technology) is an Ethernet based open field bus system which is characterized by high-speed data transfer and high real time capabilities. EtherCAT was developed by Beckhoff and is supported today by the international EtherCAT Technology Group. For further information please visit [www.ethercat.org](http://www.ethercat.org).

The Temposonics Sensor, certified in accordance to IEC61158, meets all the requirements of the EtherCAT Bus and can be connected to the bus as a slave. The sensor is integrated into the bus and parameterized with programming software. If the sensor control activates the **distributed-clock** mode the sensor's measurement cycle is synchronized by the control. This operating mode can be used for up to 5 magnets.

Temposonics EtherCAT Sensors main features:

- Output Signal: displacement, speed, status, error alert (e.g. of magnet)
- Parameter Options: direction of measurement (forwards or backwards), resolution

The sensor can be ordered with different output versions:

- **Output E101:** 1 - 5 magnet measurement (displacement and velocity measurements of up to 5 magnets simultaneously)

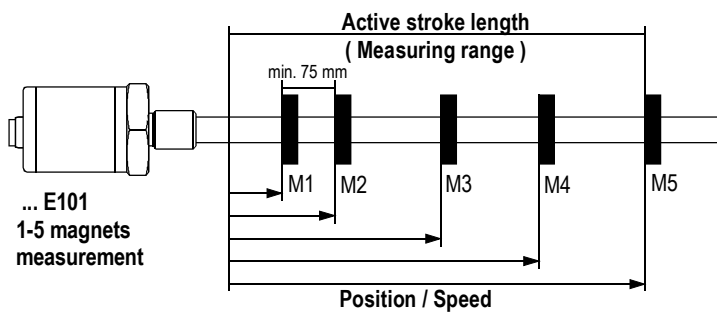

- **Output E102:** 1 – 20 magnet measurement (displacement and velocity measurements of up to 20 magnets simultaneously)

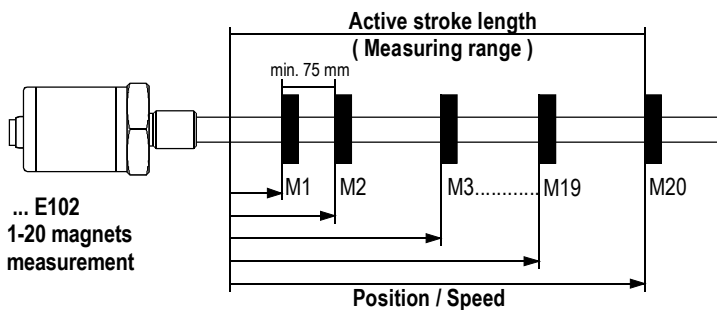

**i** Various protocols can be transmitted via EtherCAT. The CoE (CAN application layer over EtherCAT) protocol with DS406 profile is implemented in the Temposonics Sensor.

### 3. Installation



Ensure sensor mounting is kept away from strong magnetic and electrical noise-fields.  
 Sensor should be mounted exactly axial parallel to avoid damaging of position magnet and sensor housing.

#### Mounting position

The sensor may be operated in any position. Normally, the sensor is firmly installed on a straight surface of the machine, whilst the magnet head is mounted on the mobile machine part and moved over the sensor housing without contact.

#### Active stroke length = Measuring range

Start and end position of the active electrical sensor stroke is set at the factory. Areas left and right of measuring range are partly inactive and should **not** to be used for measurements. Nevertheless, they can be overrun.

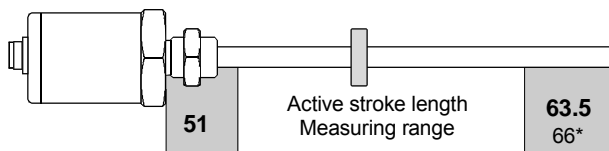
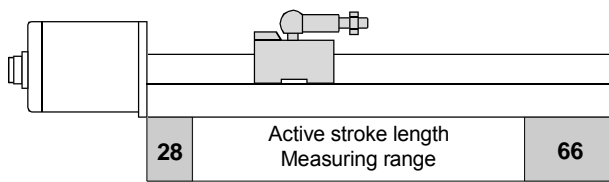

\*>5000 mm measuring range

#### Mechanical zero-point

In order to guarantee the total electrical stroke is available, position magnets must be fixed as shown:

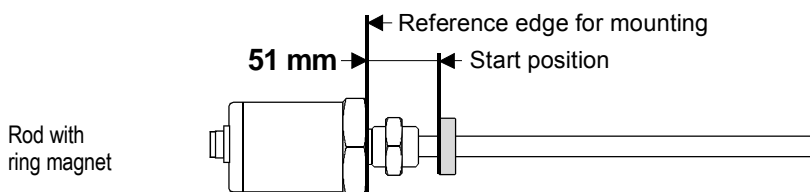
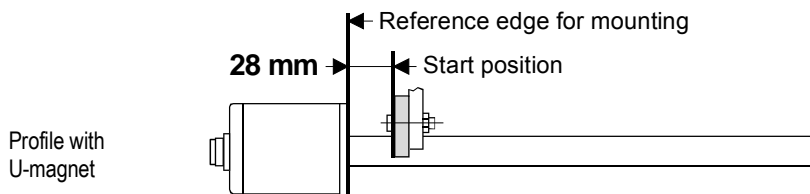
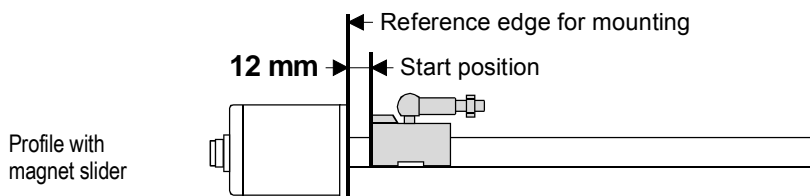

3.1 Temposonics-RP, measuring range 25...5000 mm

The profile model can be installed in accordance to customer needs and operates without contact with two versions of permanent magnets:

- Sliding magnets running in profile housing rails. Connection the moving machine part is via a ball jointed arm for taking up axial forces.
- Floating magnets on moving machine part travel over the profile with a defined gap. This gap allows the correction of small misalignments during installation ( see fig. below ).

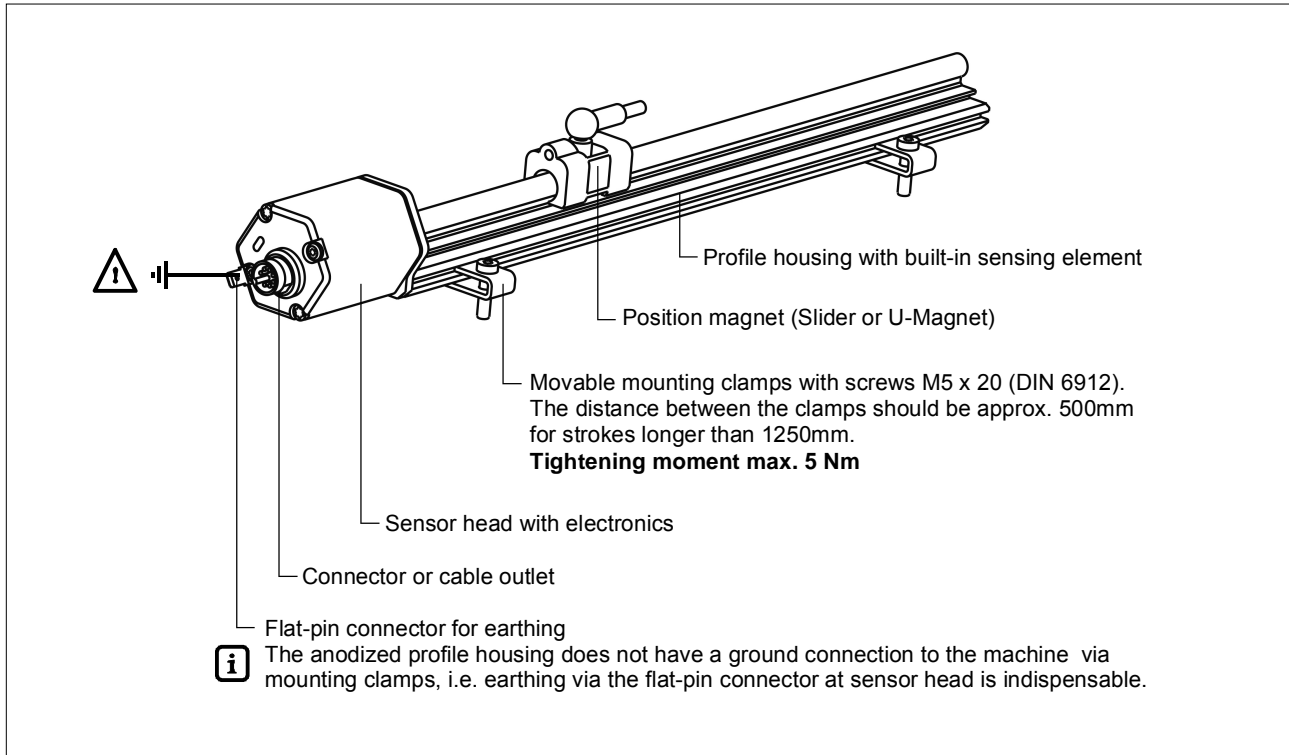

**Profile**

The profile sensor is fixed with movable mounting clamps which should be attached at each end, or, for longer sensors, spread evenly along the length of the sensor. The appropriate number of clamps is included in the delivery. Where space is a problem, the sensor can also be installed with a M5 T-slot nut in the base channel.

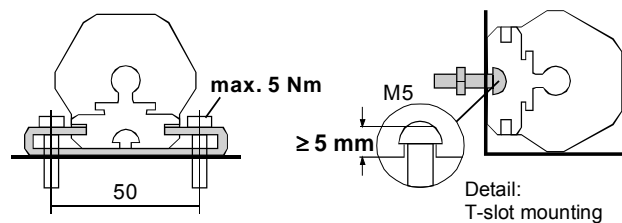

**!** The maximum torque must be observed!

**U-Magnet**

The floating U-magnet is suitable for profile or rod sensors. Non-ferrous fastening material for screws, supports etc. must be used.

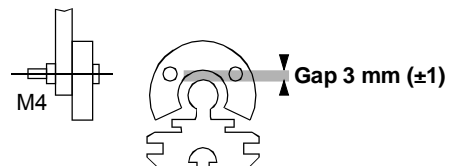

Make sure the magnet does not touch the profile. The gap allows for any misalignments during installation. Mounting notes see Temposonics-RH sensor below.

3.2 Temposonics-RH, measuring range 25...7600 mm

The sensor with a pressure-resistant stainless steel flange and sensing rod is suitable for use in hydraulic cylinders and externally in all applications where space is a problem. Position measurement is via ring magnets or U-magnets which travel along the rod without any mechanical contact.

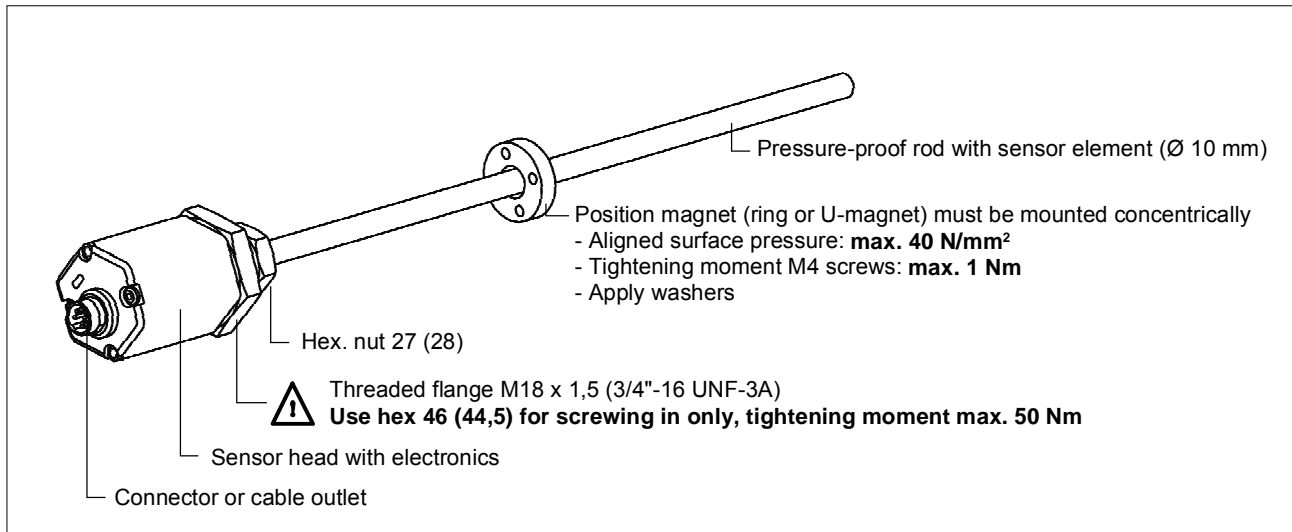

**Rod**

To install the sensor, tighten the flange thread or the hex-nut. Non-magnetic material should be used for installment. Please keep to the dimensions as shown on diagrams.



**Please use hex flange below the sensor head only when screwing on the sensor – bearing in mind the maximum fastening torque!**

1. Non-magnetic sensor mounting

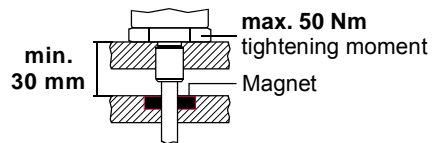

2. Magnetic sensor mounting

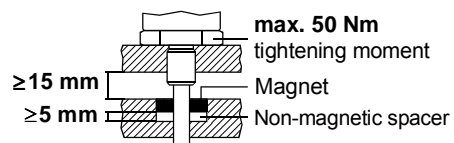

**Long sensors**

When mounting horizontally, sensors longer than 1000 mm stroke length must be supported mechanically either at the rod ends or at regular intervals along the length of the rod. U-magnets should be used for measuring.

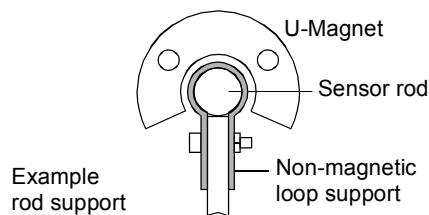

**Position magnets**

Ring magnets or U-magnets must be installed concentrically to the rod using non-magnetic fastening material for screws, spacers, supports etc. Please bear in mind the surface pressure and fastening torque!

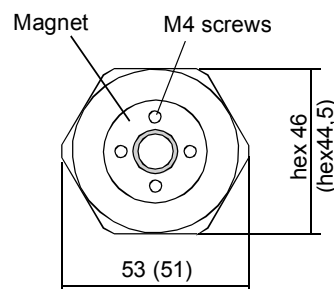



### 3.3 Fluidcylinder integration of rod sensor

For direct stroke measurement in a cylinder the rod is mounted coaxial in the bored plunger and the ring magnet fastened on the piston head as described above so that it passes along the sensor rod without touching it. The magnet marks the measured position through the rod wall of the sensor, independent of the hydraulic fluid used.

- The bore in the piston rod is dependent on hydraulic pressure and piston velocity (13 mm boring diameter minimum).
- The cylinder manufacturer is responsible for the hydraulic sealing.
- The sensor flange surface must be in full contact with the cylinder surface.
- The magnet must not touch the sensor rod.
- Do not exceed peak pressure.
- Protect sensor rod from wear.

#### Hydraulic sealing

Recommended seal: O-Ring (e.g. 22,4 x 2,65) in a groove of flange contact surface.

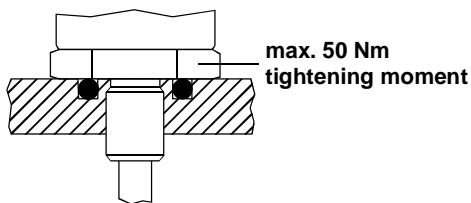

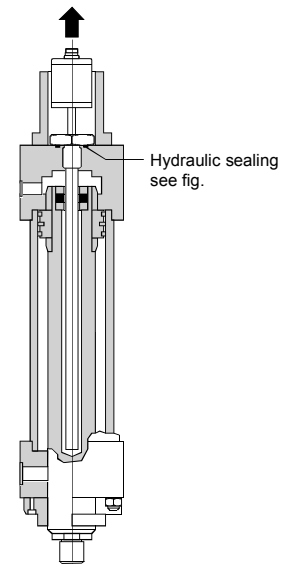
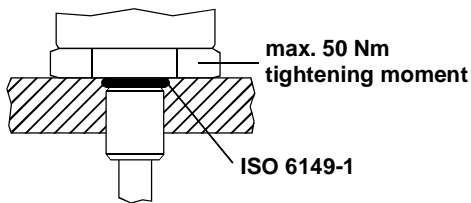

Option: O-Ring 15,3 x 2,2 in thread undercut, see ISO 6149-1 for profiling the screw plug hole.

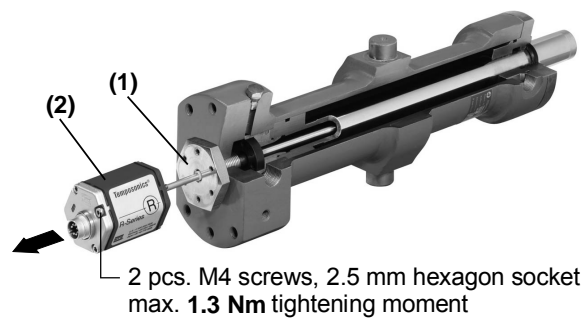
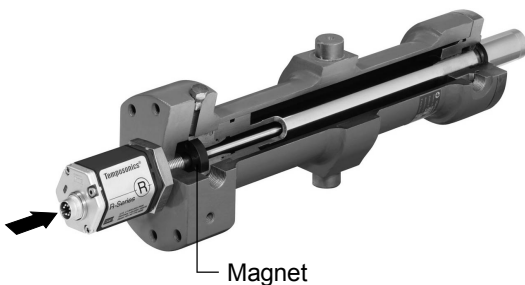

#### Simple and low-cost service

- ( 1 ) Hydraulic housing (flange with rod) stays inside cylinder.
- ( 2 ) Only sensor basis (electronics with sensor element) must be replaced via two screws M4 (2.5 mm internal hexagon).  
Hydraulic circuit can remain closed.



 After changing, fasten screws using soluble adhesive, e.g. Loctite 243.

### 3.4 Cylinder handling after sensor installation

#### 1) Painting the cylinder

Cylinders are often painted after sensor installation. The paint is usually applied electro-statically when dry or wet painting, using a very high voltage (up to 100kV) which can damage the sensor. Please observe the following rules when static-painting the cylinders:

- The sensor connection wires must be connected to each other i.e. short-circuited either by clamping or by twisting the wires together.
- The sensor connector plug on the cylinder can be connected with a mating plug to short-circuit the sensor contacts.
- Short-circuited wires/connector pins must be connected with a low resistance to the cylinder housing and to the earth ground of the paint shop. To this effect the cylinders should be suspended on the painting shop by the cylinder base and not by the piston rod to avoid an electrical isolation of the piston rod and the cylinder/sensor housing. An electrical isolation can occur due to the seal and slip rings in the cylinder which could prevent a low resistance connection between the paint shop earth wire and the sensor housing (see illustration below).
- The paint shop hanging devices and all connectors which are used to short-circuit the connector wires or to make connections to the paint shop earth wire should be cleaned of paint and other residue on a regular basis in order to ensure the low resistance connection. The electrical conductivity of these connections should be tested regularly – for example with an ohmmeter or a continuity tester.

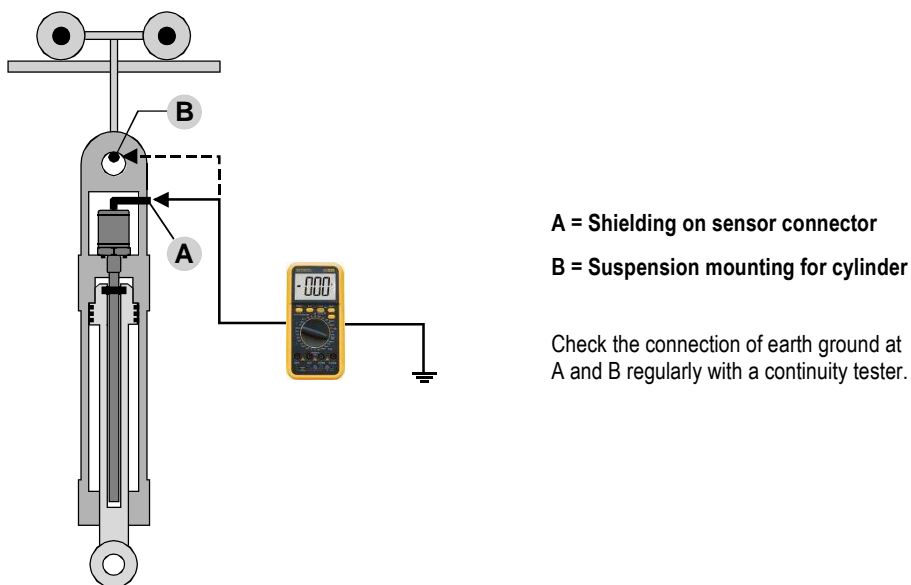
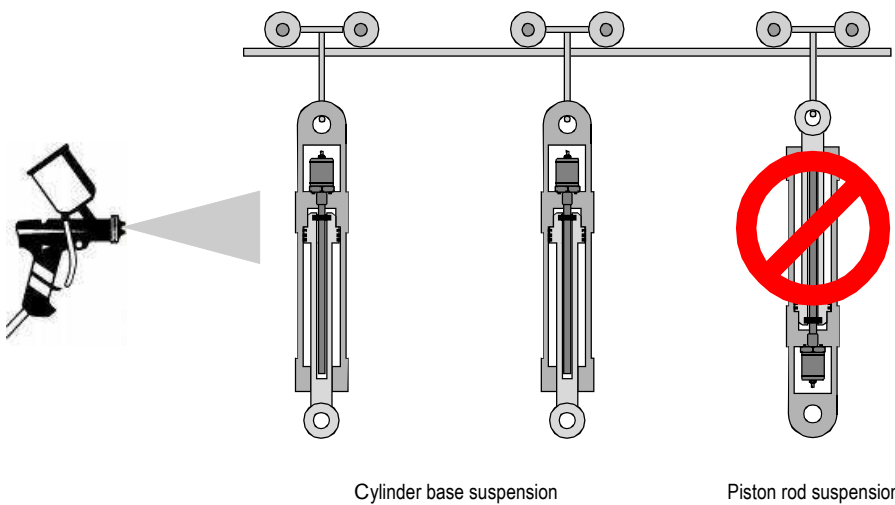

## 2) Welding

Welding often has to be carried out on cylinders. If the earth clamp is attached too close to the cylinder - or directly to the cylinder - welding currents can reach the sensor via the cylinder. This can cause damage to the electronic components of the sensor.

Cylinders are usually made up of two components: the part with the cylinder tube and the piston with the piston rod.

These components are electrically isolated from one another because of seals, bearings and skids, so that a current flow is usually not possible. However, on long sensors the sensor pipe can bend due to its weight and touch the wall of the piston rod bore. In this case there is an electrical connection and the full welding current flows through the sensor pipe and sensor head damaging the electronics.

For this reason the following points must be observed:

- Cut or disconnect all sensor connections during welding.
- Never fasten the grounding point at the piston rod or at the cylinder pipe.
- Never perform welding work on a part of the cylinder, if a sensor has been installed.
- Never perform welding work near a cylinder, if a sensor has been installed.
- Due to isolating bearings, plastic slide bearings or grease in the contact points, electric potentials/voltages can build up at every bearing point of machines. Accordingly, similar effects as on hydraulic cylinders can be produced.

### 4. Wiring

The sensor has to be connected directly with the control unit. Location and wiring have a large impact on the EMC of a sensor. As an active electronic system, it must be wired very correctly to avoid damage to its electronics due to voltage peaks or faulty connections, regardless of protection against wrong polarity. Therefore ensure the EMC of the entire machine equipment by using suitable metal connectors, screened cables earthing.

#### Bus assembly

The EtherCAT net is usually operated in a line topology. At the beginning of the line there is an EtherCAT Master, then there are a number of Temposonics Sensors (Slaves) which are connected in a row in the bus. The output connector of the last sensor remains open and is closed with a cap (see below). The maximum permitted cable length between two EtherCAT units is 100m.

#### Sensor connections, connector outlet D 56

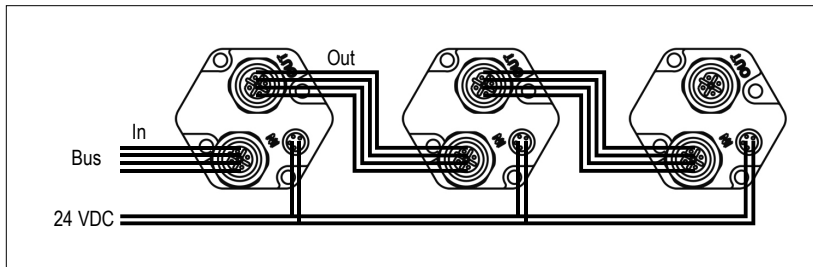

**Never connect the sensor when parts are live !**

#### Installation instructions

- Only use bus cable which meets Ethernet assembly standards.
- Keep control and signal leads away from power cables, motor cables, frequency inverters, valve lines, relays, etc.
- Only use metal connectors and connect the shielding to the connector housing.
- The shielding at each end of the cable should have the largest possible connecting surface and the cable clamps must be connected to earth ground.
- Earth connections should be kept as short as possible and with a large cross section cross section. Avoid ground loops.
- If there is a potential difference between machine and electronics earth connections, a compensating current must not be allowed to flow across the shielding.  
Our recommendation: install potential compensating lead with large profile, or use cable with separate double shielding and only place the shielding at one end each.
- Keep all unshielded cables as short as possible.
- Use only stabilized power supplies in compliance with the specified connecting values.



The profile sensor must be earthed via the flat-pin connector on the sensor head (see previous chapter on Installation).

#### Wiring diagrams (Top view sensor plug or rear soldering side of mating connector)

Separate wiring for bus in/out and input voltage with standard bus connectors:

- 2 pcs. 4 pin female connectors M12-D (Bus)
- 1 pc. 4 pin male connector M8 (voltage input)

Connectors which are not in use should be closed with a cap (see below).

Use pre-assembled Ethernet cable (see below). If the wiring is self-assembled the following parameters should be met:

- Bus: Wire gauge AWG22/7; Cable diameter 5.5...8 mm; Cable color RAL 6018; Wire colour blue, yellow, white, orange; Cable 2 twisted pairs; Shield ISO/IEC 11801 Ed. 2.0 Cat. 5; Connector M12; Cable clamp: IEC 61984
- Power line: Use shielded cable to prevent interference on the wires.

#### M12 connector (Bus in/out)

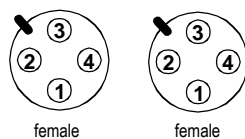

Pin	Cable	Signal
1	yellow	Tx (+)
2	white	Rx (+)
3	orange	Tx (-)
4	blue	Rx (-)

#### M8 connector (Input voltage)

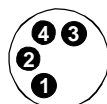

Pin	Cable	Signal
1	brown	+24 VDC (-15/+20%)
2	white	---
3	blue	DC Gnd
4	black	---

**Mating connectors (for shielding)**

- Bus: D-coded; Zinc, nickel-plated housing; screw termination; PG9 strain relief; cable diameter 6.5 - 8.5 mm.

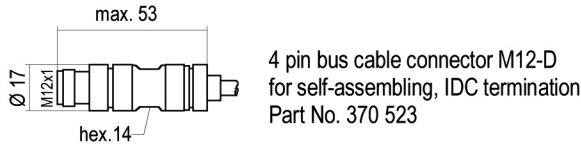

- Input voltage: Solder termination; cable diameter max. 5 mm

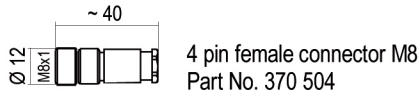

Recommendation:  
4 pin female connector M8, assembled with  
5 m PUR cable 4 x 0.25 mm<sup>2</sup>, pigtailed  
Part No. 5630 066

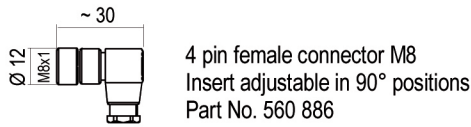

- Waterproof end cap M12: Aluminum; Part No. 370537



**Assembled bus cable**

- 5 m industrial Ethernet cable Cat 5e ES incl. 2 pcs. 4 pin connectors M12-D, PUR cable jacket, green; Part-No. 530 064

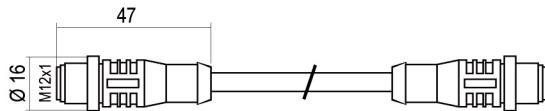

- 5 m industrial Ethernet cable Cat 5e ES incl. 1 pc. 4 pin connector M12-D and 1 pc. RJ-45 connector, PUR cable jacket, green; Part-No. 530 065

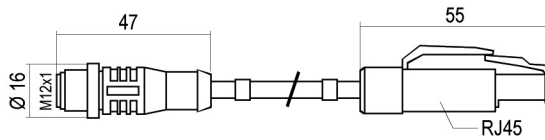

- Wiring

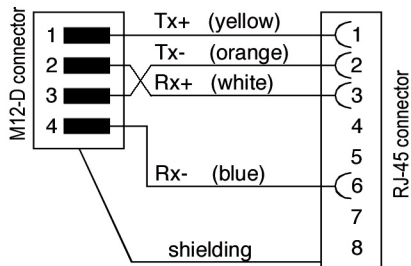

**i** For wiring mating connectors follow assembly instructions on supplier's connector packaging !

### 5. Getting started

There are numerous offers of standard hardware (Master) and configuration tools available with which an EtherCAT network can easily be set up. The installation of the Temposonics Sensors is demonstrated here with the help of components from Beckhoff Industrieelektronik (Control unit and programming software). For using alternative configuration tools follow assembly instructions of the supplier.

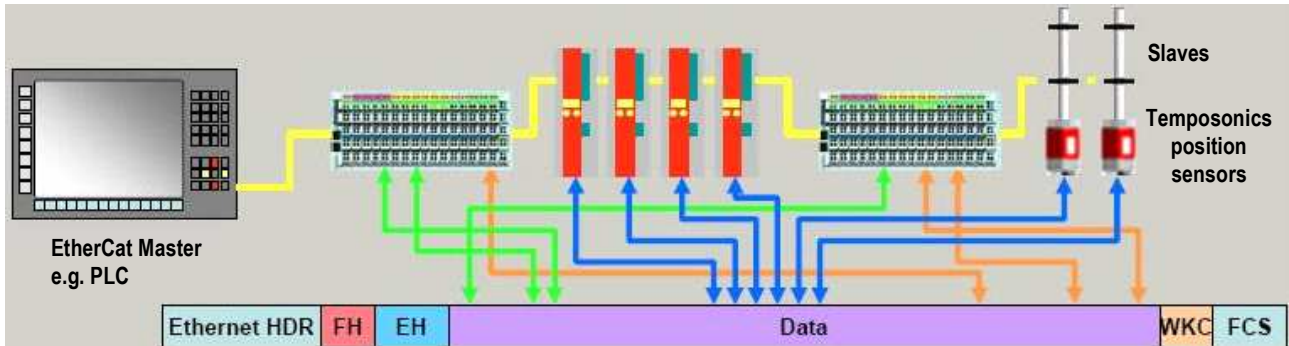

#### Factory settings

The sensors is preset on the order-dependent basic adjustments. The initialization parameters for the sensors are in the XML file which is available on the attached CD-ROM.

#### Status display

LEDs ( 3 x green / 1 x red ) on the electronics head show the current sensor status and are also used for setting the sensor parameters. The LEDs show the following:

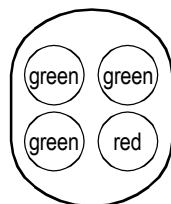
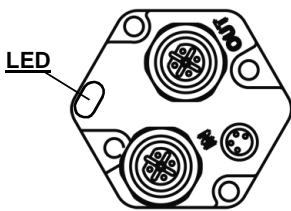

#### Green = Link OUT (Port B)

- Off: No connection
- On: Connection
- Flashing: Data transfer
- Green = DeviceStatus Mode**
- Off: Init
- flashing (Interval = 1 s): pre\_op
- Flashing (Interval = 2 s): safe\_op
- On: Operational

#### Green = Link IN (Port A)

- Off: No connection
- On: Connection
- Flashing: Data transfer

#### Red = Measurement

- On: No magnet
- Off: Signal OK
- Flashing: Input voltage beyond limits



#### Activating operation

- Before switching on for the first time, check carefully that the sensor connection is correct and make sure that the sensor/control system cannot proceed independently when switching on.
- Switch on the input voltage for sensor initialization. If the sensor is ready for use and in the operating mode after switching on, the **green** LEDs are lit.
- If data is being transferred on the network, the green LEDs of connected ports flash.

## 5.1 At a glance - brief instructions

These instructions for operation of an EtherCAT sensor are based on the programming software **TwinCAT System Manager** from Beckhoff. They are only valid for sensors with a **1-magnet measurement**. Measurements with multiple magnets are described in the following detailed configuration example.

The initialization parameters for the sensors are in the XML file which is available on the attached CD-ROM from MTS.

### 1. Add XML File (prior to first use)

Before the sensor can be configured the XML file must be copied from the CD-Rom into the TwinCAT installation directory.

File: MTS\_EtherCAT\_xxx.xml  
Directory: C:\<Installationspfad>\TwinCAT\IO\EtherCAT  
Then restart the TwinCAT System Manager!

### 2. Connect sensor to the bus

Make sure that the shielding, wiring and bus connector are correct. When turning on the sensor all four LEDs on the sensor light up. The LEDs in the sensor head indicate the operating status of the sensor (see above).

### 3. Add the network interface card as an I/O device

On starting the TwinCAT System Manager expand the **I/O configuration** in the file tree on the left hand side via

- Right click on **I/O Device**
- Click **Scan Devices**
- Confirm with **OK** as appropriate.
- The network card previously configured in the master is listed as I/O Device in the next menu.
- Click on **OK** to close the menu. The device is now added to the file tree.

### 4. Sensor addition as a box

When the menu described under point 3 has been closed with **OK** a further window is opened for connected sensors.

- Answer with **Yes**. The connected sensors are listed in the file tree on the left.
- Click on **Yes** in the new window for the sensor **Free Run mode** or otherwise on **No**.
- The Free Run mode enables the sensor to report position, speed and acceleration - independent of whether a task is configured and activated.
- Activate **Reload I/O Devices** in the toolbar: this updates the changed values in the sensor.

### 5. Parameterize the sensor with the CoE Mailbox

On selecting the sensor [ **Box < Nr > (MTS Temposonics)** ] in the file tree a menu appears in the main window with tabs.

- Select tab **CoE-Online**
- The sensor parameters are listed
- The values can be changed to the appropriate parameter by double-clicking
- The authorization for changing values is shown in the **Flags** column (RO = Read Only / RW = Read Write)

## 6. Example of configuration: TwinCAT System Manager (Beckhoff)

For the operation of the EtherCAT Bus in this example, the following components are required:

- Temposonics Position Sensor with EtherCAT interface
- Electronic data sheet (GSD file) as detailed on the CD-ROM provided which contains the default settings of the sensor parameters in a XML file. This file is used to inform TwinCAT of characteristics and performance of the bus sensors.
- EtherCAT Master (e.g. IPC) with Windows OS
- EtherCAT Master-Software 'TwinCAT System Manager'

The sensor is integrated into the bus system using the TwinCAT System Manager and XML-File (CD-Rom) from MTS. This file can also be downloaded from **Support/Software** at [www.mtssensor.com](http://www.mtssensor.com).

The sensors are set up as follows:

1. Install programming software TwinCAT System Manager
2. Copy the XML-File to TwinCAT
3. Test EtherCAT driver for Ethernet card
4. Start TwinCAT System Manager
5. Set up parameters

The parameters needed for EtherCAT are set up in the TwinCAT software as necessary. The manual input of node address and baud rate is not necessary – simply select the network devices in the system manager and list accordingly.

### 6.1 Configuration of Ethernet card

A normal Ethernet card is needed for the master in order to use an EtherCAT network. The EtherCAT drivers must be installed and the appropriate Ethernet card activated before the data frame can be read. The status can be checked by opening the network at **Windows Start-button / Control Panel / Network Connections**.

The window shown at Fig. 1 is opened with a right click on the appropriate EtherCAT LAN connection. Check that **ECAT Filter Driver** and **TwinCAT RT-Ethernet Intermediate Driver** are activated and confirm with **OK**.

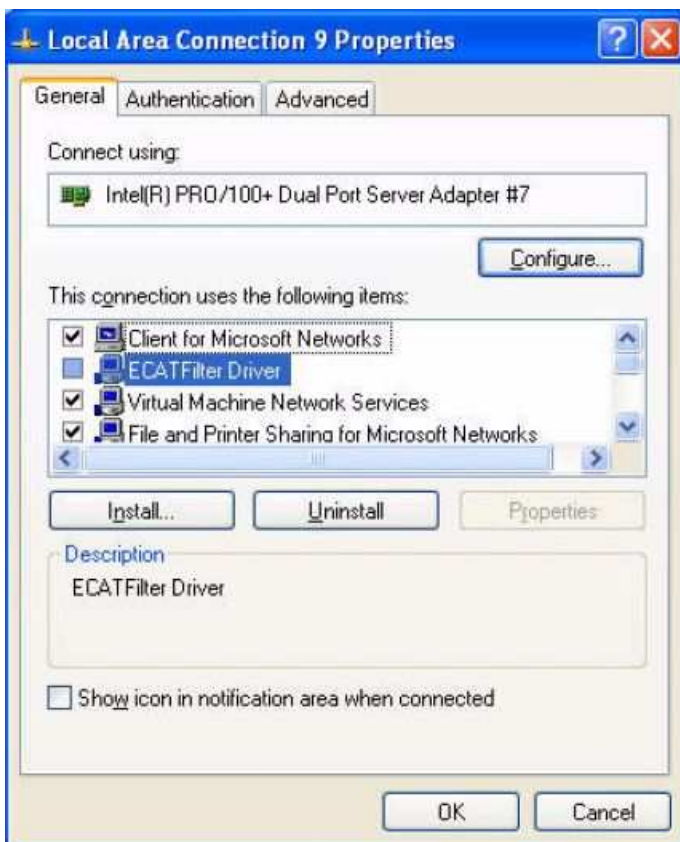

Fig. 1



### 6.2 Starting TwinCAT System Manager

Right click on **TwinCAT** in the Task Menu and select **System Manager**



Fig. 2

### 6.3 Add the Ethernet card as an I/O device

On starting the TwinCAT System Manager the window shown at Fig. 3 is opened.

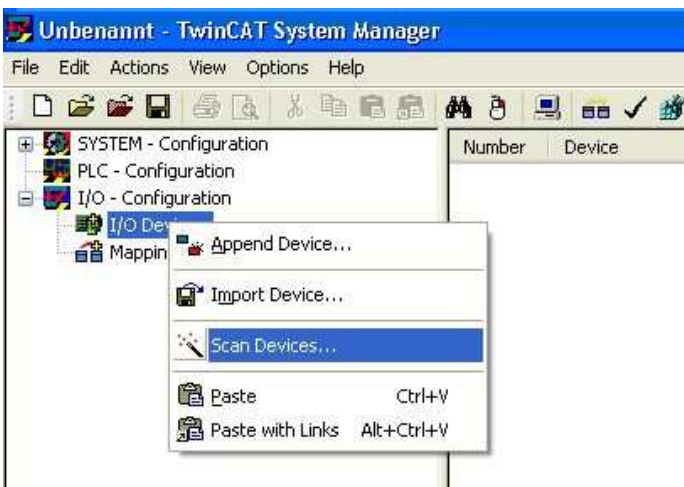

Fig. 3

An automatic search for a I/O Device (in this case the appropriate interface card) is initiated by a right click on **I/O Device** and then marking **Scan Devices**. The following dialogue box is opened (Fig. 4). Click on **OK** to search further.



Fig. 4

A new menu is now opened showing the EtherCAT interface card found and added to the file tree as I/O Device.

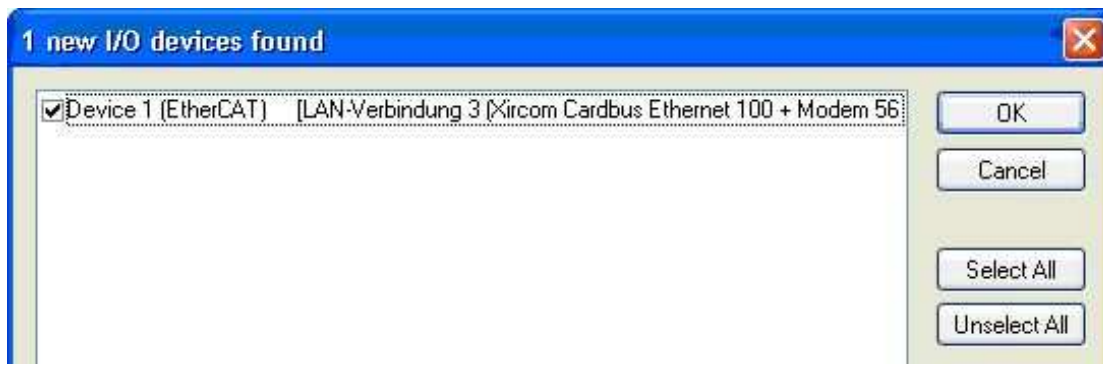

Fig. 5

Confirm with **OK**. A new dialogue box is opened (Fig. 6).

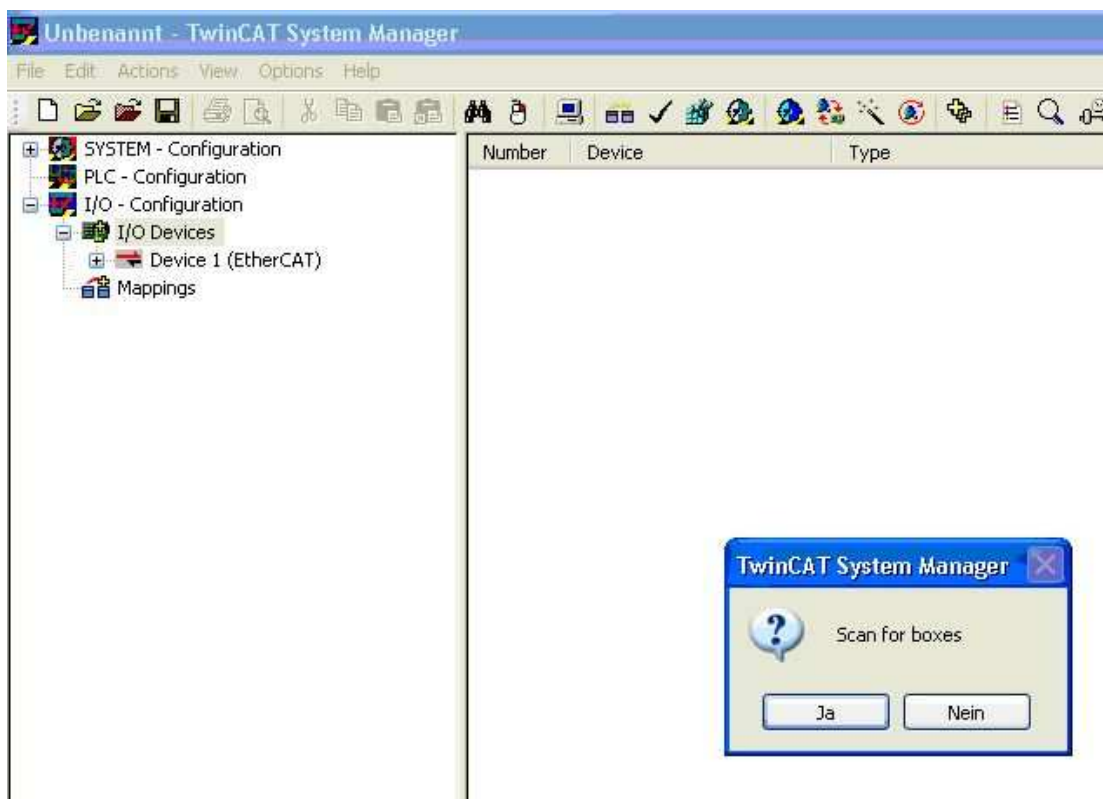

Fig. 6



If the sensors are used with **one magnet only** the System Manager automatic search can be used to add these sensors to the EtherCAT device. In this case click on **Yes (Ja)** and continue to section automatic addition.  
 If multi-magnet sensors are used click on **No (Nein)** and add the sensors manually to the EtherCat device as described at manual addition.

### 6.4 Adding a sensor as a Box

#### 1) Automatic addition

The automatic search recognizes the sensor and a dialogue box is opened which asks whether the **Free Run** mode should be activated (Fig. 7). The sensor is added to corresponding I/O Device in the file system. The Free Run mode reports the position, speed and acceleration of the sensor – independent of whether a task is configured and activated. **Yes (Ja)** tests the sensor / **No (Nein)** closes the dialogue box.

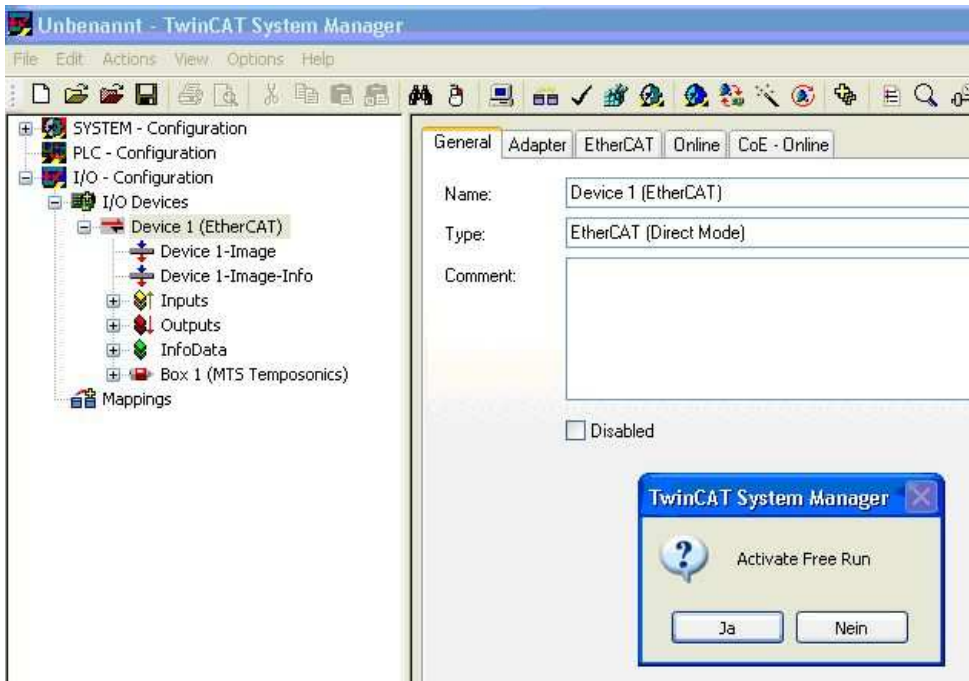

Fig. 7

#### 2) Manual addition

Right click on the **EtherCAT** symbol in the file tree in Figure 7. In the new window which opens (not shown) select **Add Box**. Then open **MTS Systems Corp** in the window which opens next (Fig. 8) and select the sensor with the **number of magnets** required. Confirm with **OK**. The additional sensor is added to the file tree system.

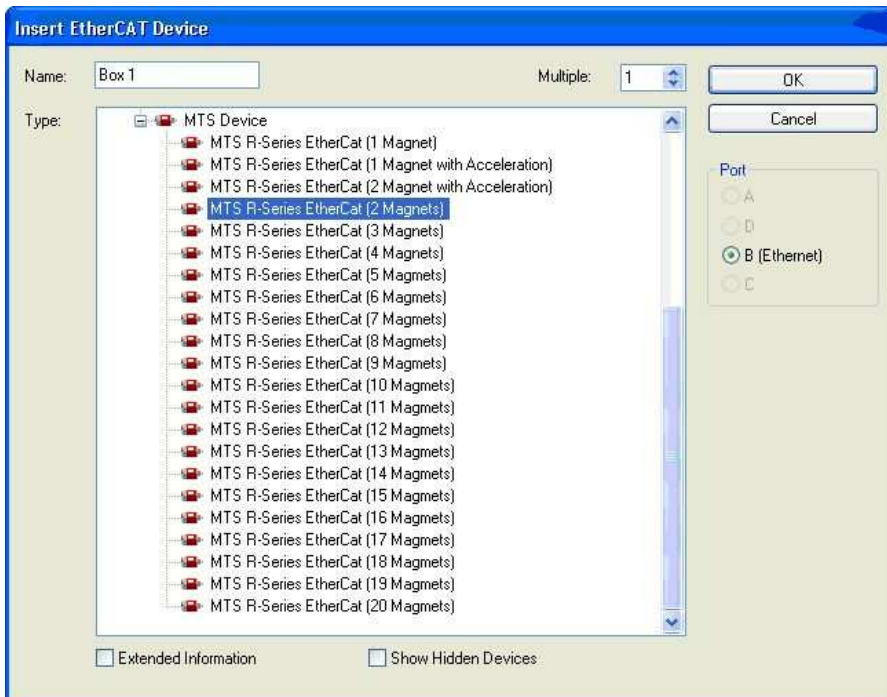



Fig. 8

Activate the button  (Reload I/O Device) in the tool bar in order to update the configuration (see chapter 8 below). The **Free Run** mode activation window opens (Fig. 7). The Free Run reports the position, speed and acceleration of the sensor – independent of whether a task is configured and activated. **Yes** tests the sensor. **No** closes the window.

### 6.5 Setting up and parameterizing the sensor

After adding the sensor as a box it can be set up and the parameters can be modified. Click on the **Box** required in the file tree. The sensor set-up tabs are opened in the main window (Fig. 9).

#### 1) General

The **Name** and the **ID** of the sensor can be changed here.

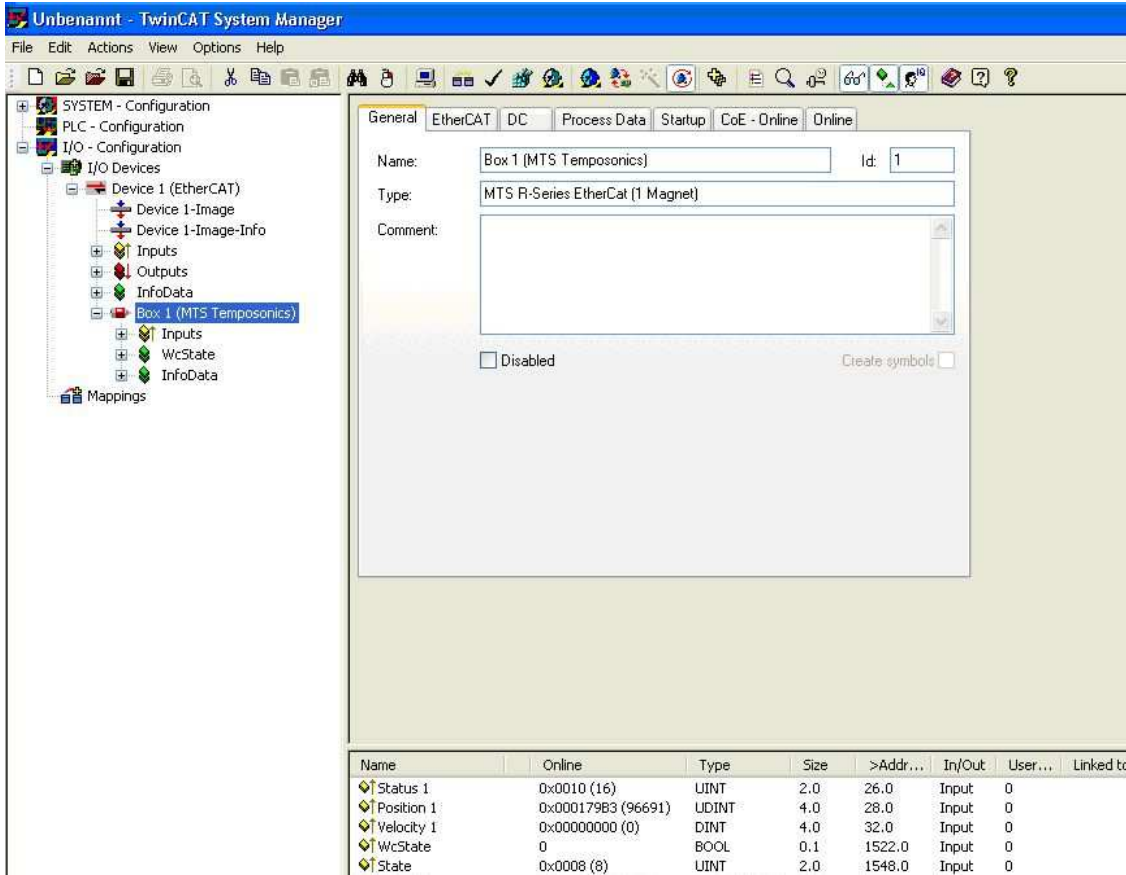

Fig. 9

#### 2) EtherCAT

This tab includes the **Product No.** and **Revision** of the sensor. By clicking on **Advanced Settings** certain Product numbers and Revisions can be approved.

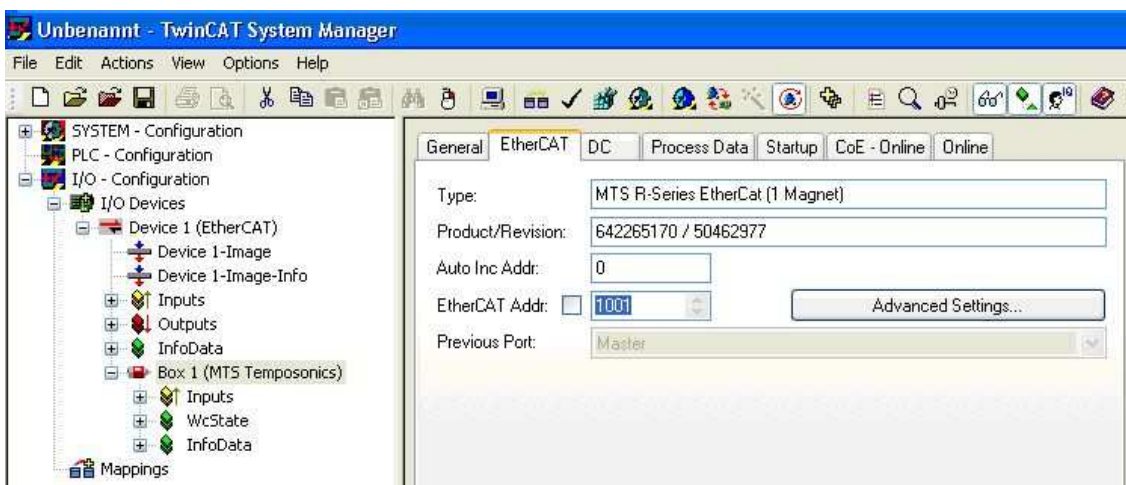

Fig. 10

3) DC (Distributed Clock)

The **Distributed Clock** mode which synchronises the measurement cycle of the sensor by control unit, can be changed.

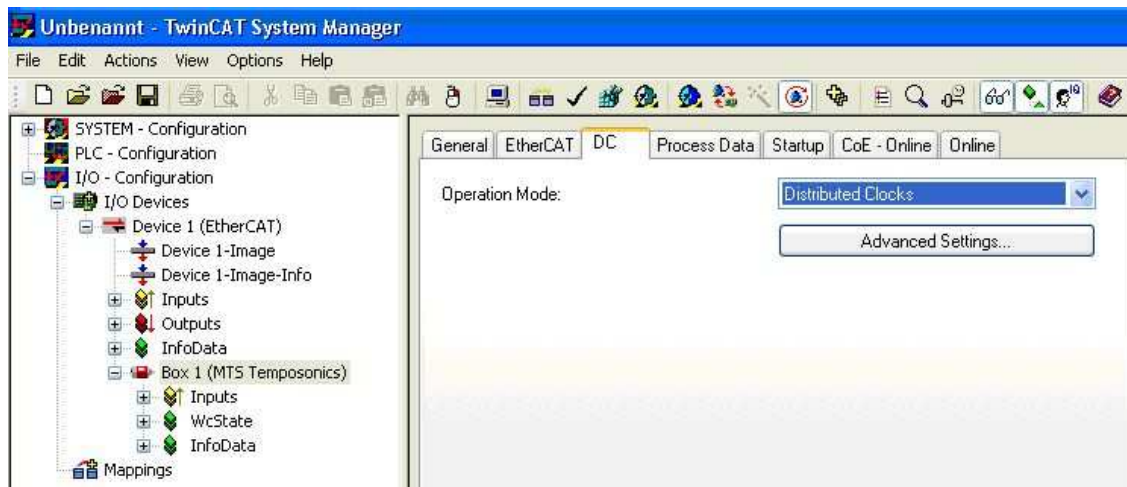

Fig. 11

4) StartUp

The Startup tab can be used to insert Mails which are transmitted to the sensor when starting up. After clicking on **New** a new Mail can be prepared which is then transmitted to the sensor at the next start up (Fig. 13).

The transition in which the new Mail is to be sent can be selected at the State Machine. The transmission goes via a CoE protocol (CoE = CANopen application layer over EtherCAT). Startup enables a sensor to be replaced to meet different requirements without having to re-configure the new sensor.

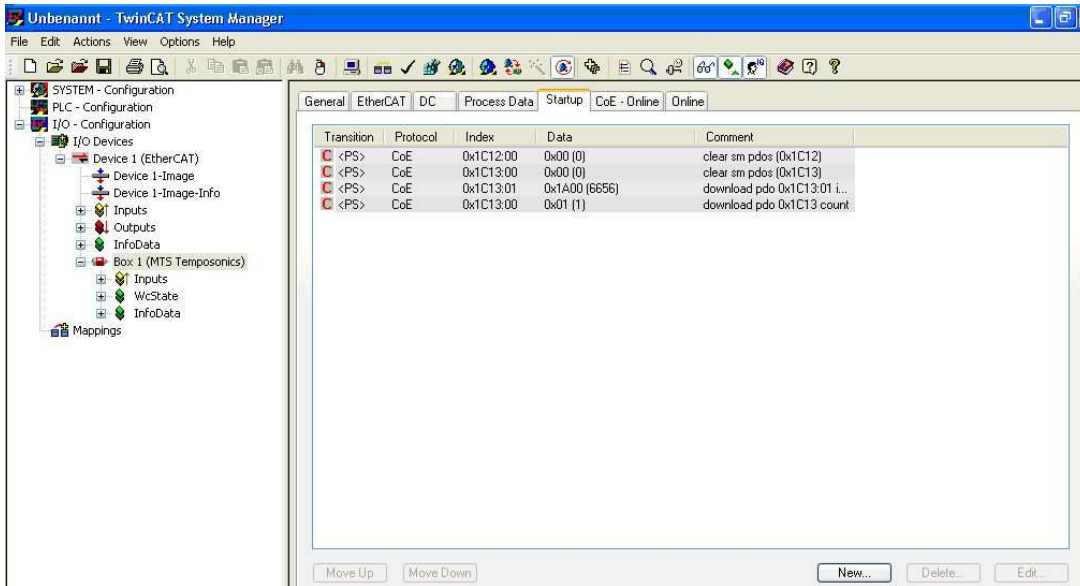

Fig. 12

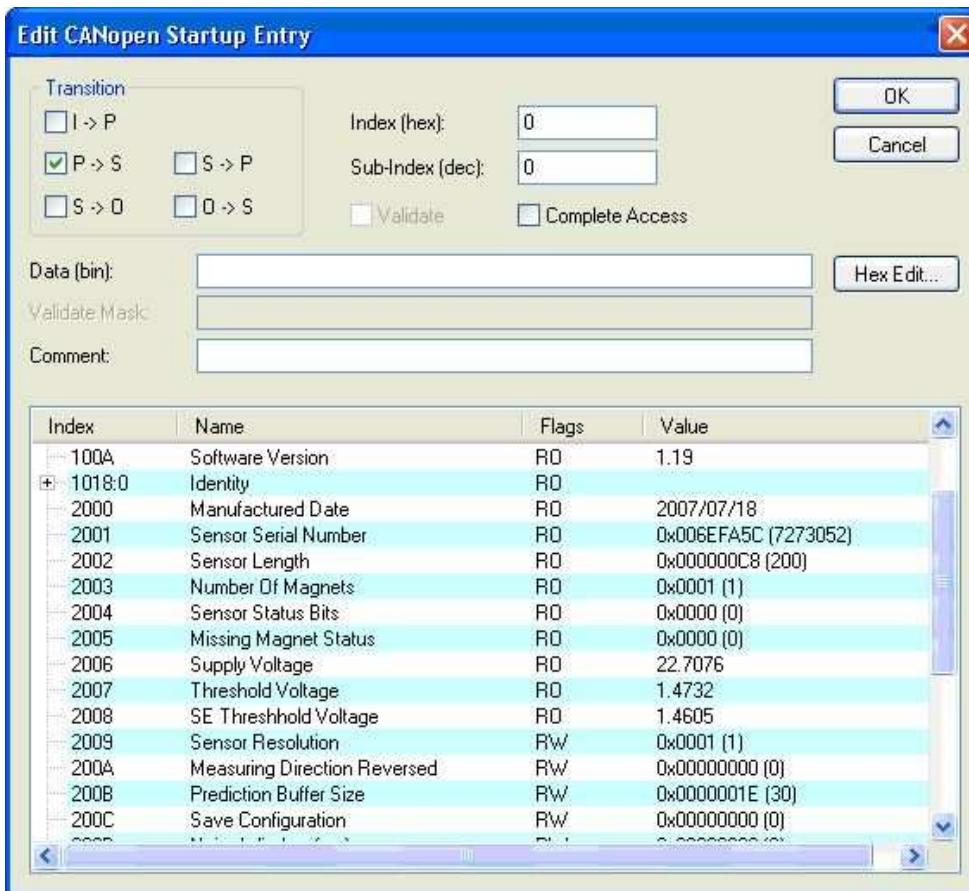

Fig. 13

5) CoE-Online (CANopen application layer over EtherCAT)

CoE lists the sensor's parameters. The **Flags** column shows whether read (RO = Read Only) or read and write (RW) rights are available for the parameter. If RW rights are available the parameter can be changed by double clicking on the parameter and the alterations are sent to the sensor via the CoE-Mailbox.

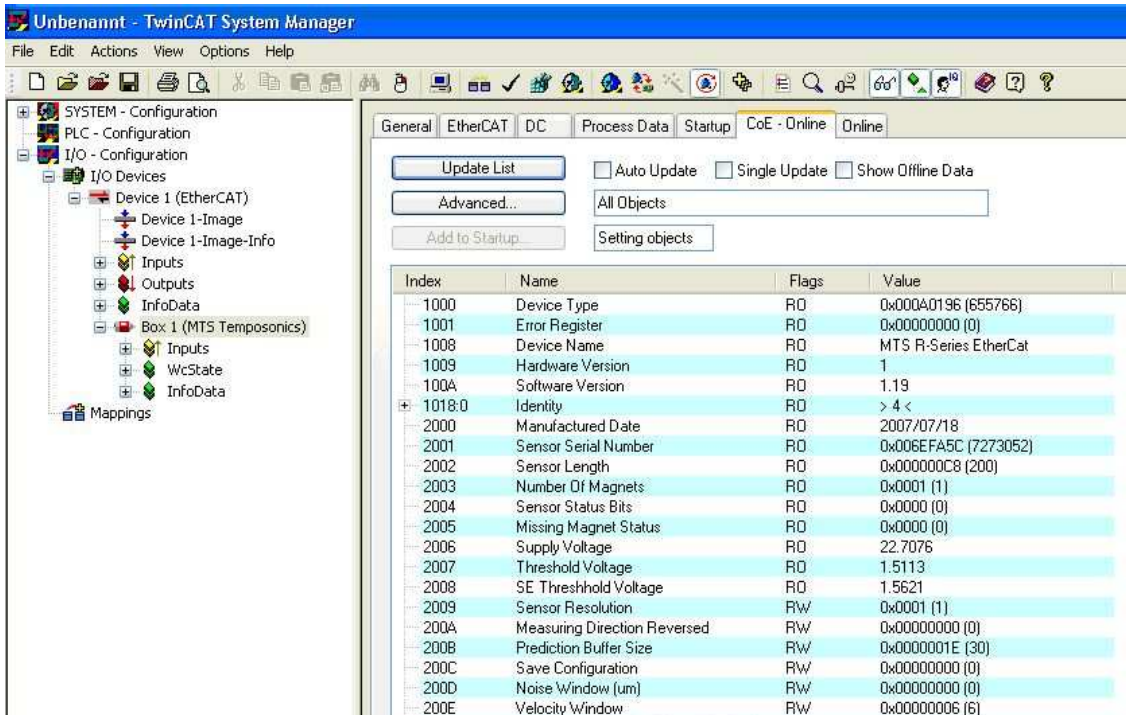

Fig. 14

6) Online

The Online tab shows the state machine of the sensor. The fields on the right show the current state and the requested state. By clicking on the buttons on the left a transition to a different sensor status can be requested.

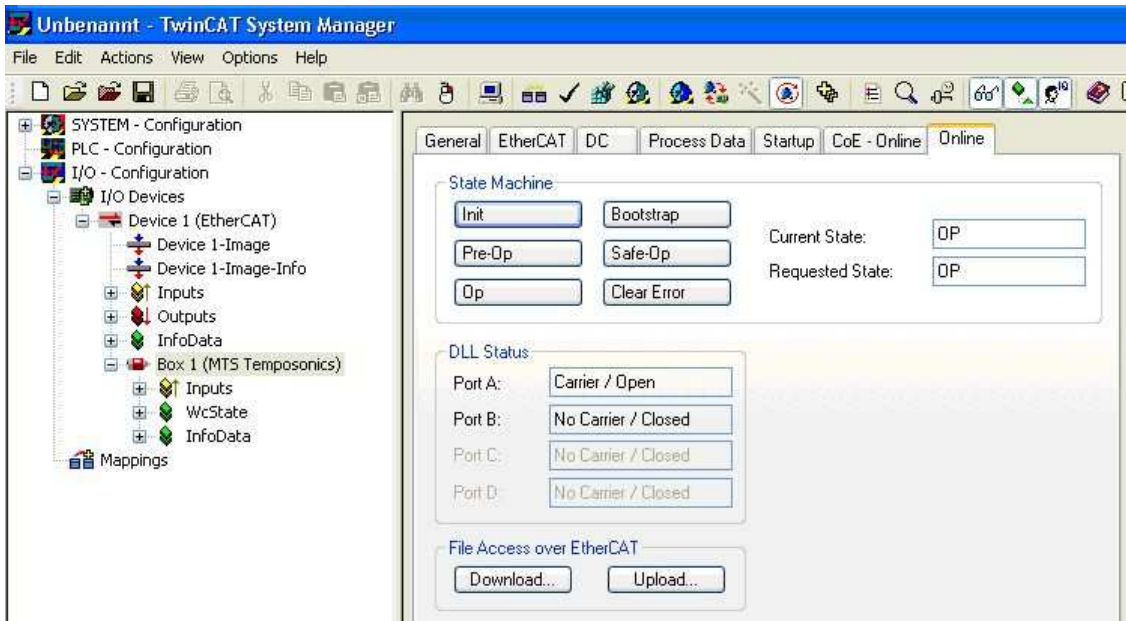

Fig. 15

### 6.6 Sensor in operation

The sensor delivers input data into the process image in Free Run mode. On opening up the file system at **Inputs** the data is updated in the main window in the **Online** column (Figure 16). The amount of data is dependent on the number of magnets. The status, position and speed of each magnet is listed hexadecimally (decimally) in the **Online** column.

#### 1) Status

The status is a 2 byte number without prefix. Byte 1 is empty, Byte 2 shows the magnets and reports failures.

Example: 0x0010 Magnet No. 1 is OK  
 0x0018 Magnet No. 1 shows the failure bit

#### 2) Position

The position is a 4 byte number without prefix. This value does not have a unit and must therefore be multiplied by the resolution in metres.

Example: Magnet No. 1 shows position value of 0x0000E998 ( 59800 ), a selected resolution of 1  $\mu$  results in a value of 59,8 mm.

#### 3) Velocity

The velocity is shown as a 4 byte number with prefix. When the magnet moves away from the sensor head the speed value is positive and in the opposite direction it is negative. This value has no unit and must therefore be multiplied by  $\mu$ /sec.

Example: Magnet No. 1 shows a speed value of 0x00030D4 ( 200000 ), a selected position resolution of 1  $\mu$  results in 200 mm/sec.

#### 4) Acceleration

The acceleration of a maximum of 2 magnets is optional. In this case it is given with an additional 4 bytes. The prefix is independent of the direction of movement. A negative value depicts a deceleration of the magnet.

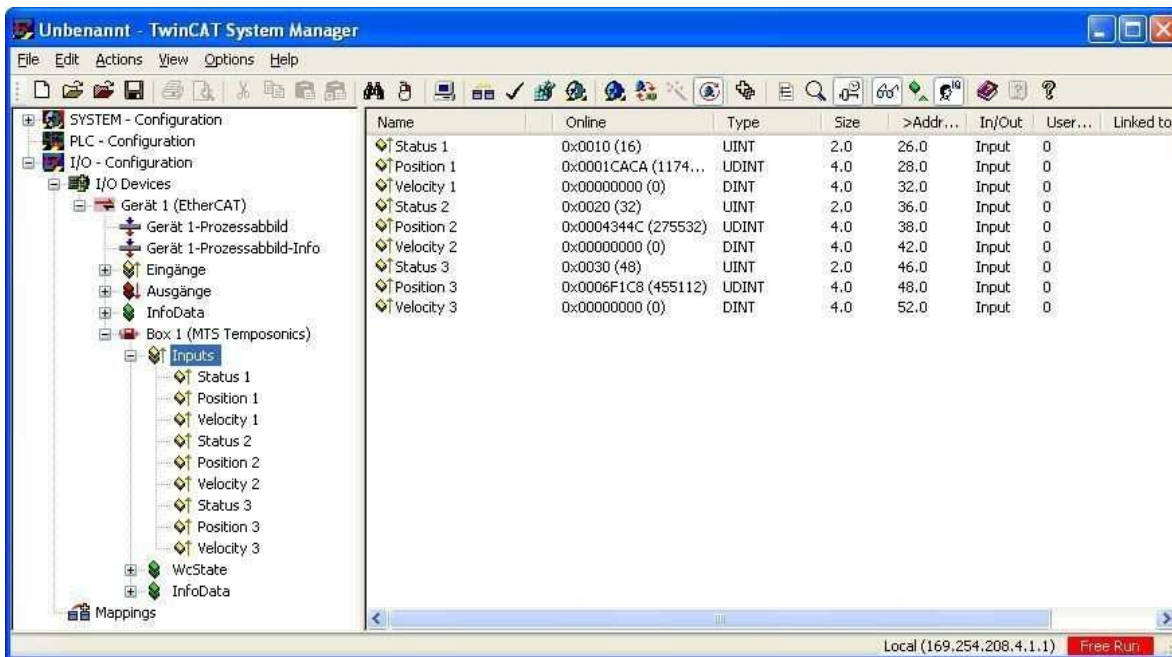

Fig. 16



## 7. Annex TwinCAT

### 7.1 Description of tool bar buttons



#### Set/Reset TwinCAT to Config Mode

The TwinCAT system can be put into Config Mode with this button. This allows a remote configuration of a PLC for example. The current mode is indicated in the bottom right-hand corner of the system manager.



#### Reload I/O Devices

The active I/O driver configuration of controller software can be replaced with this button.



#### Scan Sub Devices

If the I/O Devices is selected in the file tree, this button can be activated. A search for connected I/O devices, for example an Ethernet card, is then started. If an I/O Device is found a new search looks for boxes or sensors which are connected to the I/O Device.



In order to carry out this function control unit (PLC) must be in Config Mode.



#### Toggle Free Run State

When the control unit is in Config Mode, the sensor can be put into Free Run Mode with this button. The position, speed and acceleration of the sensor can then be reported even without configured and activated tasks (e.g. without PLC project).



If the control unit was previously in Run Mode the **Reload I/O Devices** tool bar button must be activated a single time in order to be able to put the sensor into Free Run Mode.

### 7.2 CAN Indices

The lists shown in Figures 17 and 18 are only a small section of the standard and sensor object indices in the CAN-application layer over-Ethernet Communication Protocol. The complete index lists are described in a separate appendix.

#### Standard objects

Index	Name	Flags	Value
1000	Device Type	RO	0x000A0196 (655766)
1001	Error Register	RO	0x00000000 (0)
1008	Device Name	RO	MTS R-Series EtherCat
1009	Hardware Version	RO	1
100A	Software Version	RO	1.19
1018:0	Identity	RO	> 4 <
1018:01	Vendor Id	RO	0x00000040 (64)
1018:02	Product Code	RO	0x00000001 (1)
1018:03	Revision Number	RO	0x00000077 (119)
1018:04	Serial Number	RO	0x006EFA5C (7273052)

Fig. 17

#### Sensor objects

Index	Name	Flags	Value
2000	Manufactured Date	RO	2007/07/18
2001	Sensor Serial Number	RO	0x006EFA5C (7273052)
2002	Sensor Length	RO	0x000000C8 (200)
2003	Number Of Magnets	RO	0x0001 (1)
2004	Sensor Status Bits	RO	0x0000 (0)
2005	Missing Magnet Status	RO	0x0000 (0)
2006	Supply Voltage	RO	22.7076
2007	Threshold Voltage	RO	1.4732
2008	SE Threshold Voltage	RO	1.4478
2009	Sensor Resolution	RW	0x0001 (1)
200A	Measuring Direction Reversed	RW	0x00000000 (0)
200B	Prediction Buffer Size	RW	0x0000001E (30)
200C	Save Configuration	RW	0x00000000 (0)
200D	Noise Window (um)	RW	0x00000000 (0)
200E	Velocity Window	RW	0x00000006 (6)
200F	Enable Smart Missing Magnet Detecti...	RW	0x00000000 (0)

Fig.18

## 8. Sensor specifications

<b>Input variables</b>	Measured parameters Measuring range	Position, velocity, 1-5 magnets measurements, option: 1-20 magnets measurements Profile: 25 - 5000 mm / Rod: 25 - 7600 mm / Flexible rod sensor: 100 – 15,000 mm
<b>Output signal</b>	Interface Data protocol Baud rate	EtherCAT Ethernet Control Automation Technology EtherCAT 100 Base-Tx, Fast Ethernet 100 MBit/s
<b>Accuracy</b>	Resolution Linearity Repeatability Update time Processdata Temperature coefficient Ripple Hysteresis	Position: 1 ... 1000 µm selectable / Velocity: 1 µm/s < ± 0.01 % F.S. (Minimum ± 50 µm) < ± 0.001 % F.S. (Minimum ± 2.5 µm) Dependent on stroke Maximum ≤ 10 KHz, data extrapolated <15 ppm/° C < 5 µm < 4 µm
<b>Operating conditions</b>	Magnet speed Operating temperature Dew point, humidity Protection Shock test Vibration test Standards, EMC test	Any -40 °C ... +75 °C 90% rel. humidity, no condensation Profile: IP65, Rod: IP67 if mating connector is correctly fitted 100 g (Single hit, IEC-Standard 68-2-27) 15g / 10 - 2000 Hz, IEC-Standard 68-2-6 Electromagnetic emission EN 50081-1; Electromagnetic immunity EN 50082-2; EN 61000-4-2/3/4/6, Level 3/4, Criterion A, CE-qualified
<b>Formfactor, material</b>	Diagnostic display <u>Profile model:</u> Sensor head Sensor stroke Positions magnet <u>Rod model:</u> Sensor head Rod with flange Position magnet	LEDs on top of sensor head Aluminum Aluminum Slider/U-magnet, distance between 2 magnets: > 76 mm, operating range > 50 mm Aluminum Stainless steel 1.4301 / AISI 304; Pressure rating: 350 bar, 700 bar peak Ring/U-magnet, distance between 2 magnets: > 76 mm, operating range > 50 mm
<b>Installation</b>	Mounting position Profile Rod Position magnet	Any Movable mounting clamps or T-slot nuts M5 in base channel Threaded flange M18 x 1.5 or 3/4" -16 UNF-3A, Hex nut M18 Antimagnetic material for mounting plate and screws
<b>Electrical connection</b>	Connection type Input voltage - Polarity protection - Overvoltage protection Current consumption Ripple Electric strength	1 x 4 pin connector M12-D, 1 x 4 pin connector M8 24 VDC (-15 / +20 %) up to -30 VDC up to 36 VDC 80 mA typical < 1 % peak to peak 500 VDC (DC ground to machine ground)

**Notes:**

**Document Part Number: 551488 Revision A (EN) 12/2013**

MTS and Temposonics® are registered trademarks of MTS Systems Corporation. All other trademarks are the property of their respective owners. Printed in Germany.

Copyright © 2013 MTS Sensor Technologie GmbH & Co. KG. Alterations reserved. All rights reserved in all media. No license of any intellectual property rights is granted. The information is subject to change without notice and replaces all data sheets previously supplied. The availability of components on the market is subject to considerable fluctuation and to accelerated technical progress. Therefore we reserve the right to alter certain components of our products depending on their availability. In the event that product approbations or other circumstances related to your application do not allow a change in components, a continuous supply with unaltered components must be agreed by specific contract.



**MTS Sensor Technologie  
GmbH & Co. KG**  
Auf dem Schüffel 9  
58513 Lüdenscheid, Germany  
Tel. + 49-23 51-95 87 0  
Fax + 49-23 51-5 64 91  
E-Mail: [info@mtssensor.de](mailto:info@mtssensor.de)  
[www.mtssensor.de](http://www.mtssensor.de)

**MTS Systems Corporation**  
Sensors Division  
3001 Sheldon Drive  
Cary, N.C. 27513, USA  
Tel. + 1-919-677-0100  
Fax + 1-919-677-0200  
E-Mail: [sensorsinfo@mts.com](mailto:sensorsinfo@mts.com)  
[www.mtssensors.com](http://www.mtssensors.com)

**MTS Sensors Technology Corp.**  
737 Aihara-cho,  
Machida-shi, Japan  
Tel. + 81-42-775-3838  
Fax + 81-42-775-5516  
E-Mail: [info@mtssensor.co.jp](mailto:info@mtssensor.co.jp)  
[www.mtssensor.co.jp](http://www.mtssensor.co.jp)